

1988 JS440 PARTS DIAGRAM

Crankshaft/Pistons

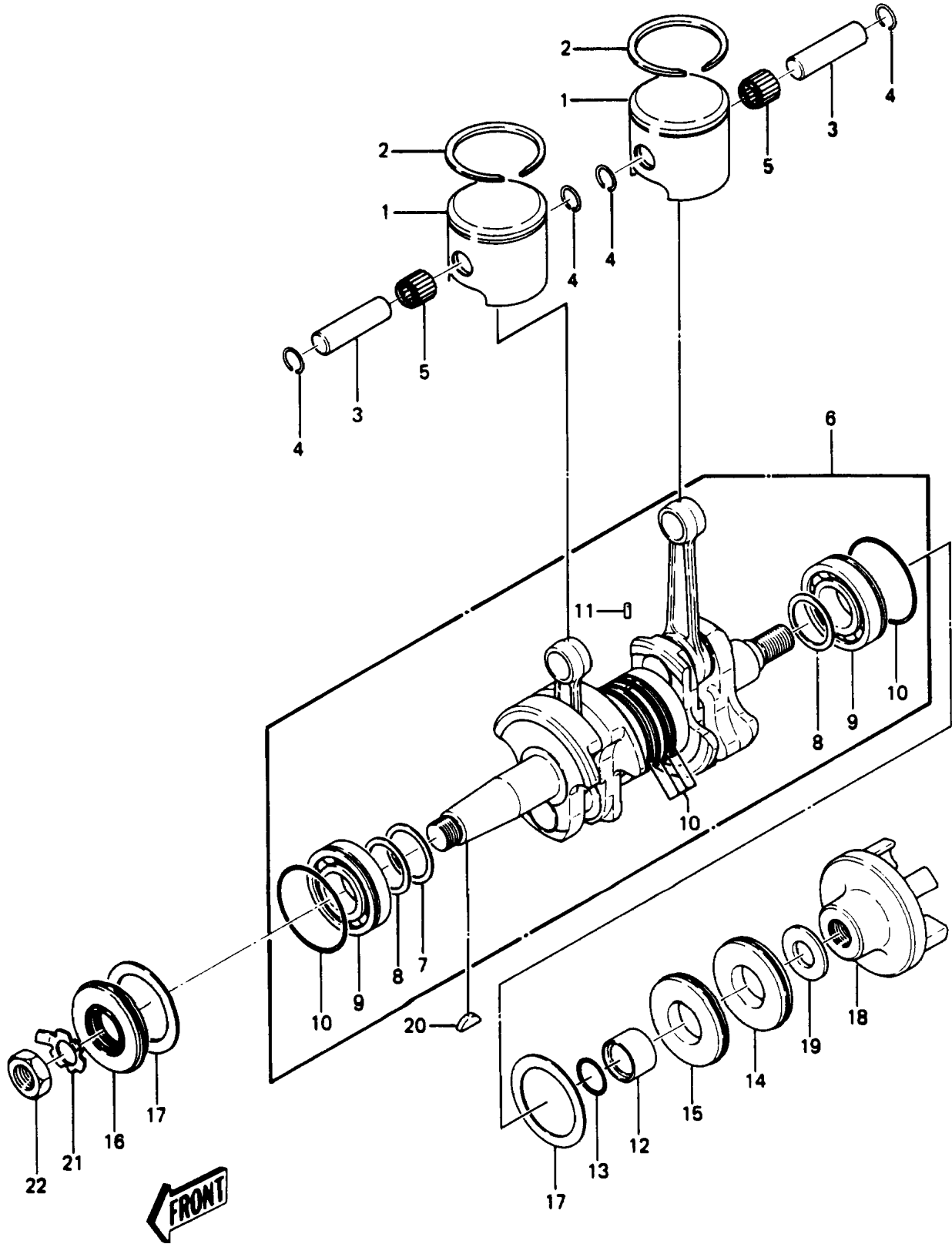

1988 JS440 PARTS LIST

Crankshaft/Pistons

ITEM NAME	PART NUMBER	QUANTITY
RING-O (Ref # 10)	92055-504	6
PIN-DOWEL (Ref # 11)	551A0410	1
SLEEVE,CRANKSHAFT OUT (Ref # 12)	42036-3007	1
RING-O,22MM (Ref # 13)	92055-3009	1
SEAL-OIL,OIL,TCY306210 (Ref # 14)	92049-3005	1
SEAL-OIL,OIL,DCY30629 (Ref # 15)	92049-3006	1
SEAL-OIL,TCY306210 (Ref # 16)	92050-507	1
WASHER,CRANK,RH (Ref # 17)	92022-3021	2
COUPLING (Ref # 18)	42034-3005	1
WASHER,18.5X38X4 (Ref # 19)	92022-3028	1
KEY-WOODRUFF (Ref # 20)	510A5200	1
WASHER,LOCK,20MM (Ref # 21)	92022-569	1
NUT,20MM (Ref # 22)	92015-535	1
PISTON-ENGINE L,O/S 0.50MM (Ref # 1A)	13029-3001	2
PISTON-ENGINE (Ref # 1)	13001-3017	2
RING-PISTON TOP,O/S 0.50MM (Ref # 2A)	13003-3015	2
RING-PISTON TOP (Ref # 2)	13003-3014	2
PIN-PISTON (Ref # 3)	13002-504	2
RING-SNAP (Ref # 4)	92036-507	4
BEARING-NEEDLE (Ref # 5)	92046-503	2
CRANKSHAFT-COMP (Ref # 6)	13031-3011	1
SHIM,T=1.0MM (Ref # 7)	92025-532	1
SHIM,T=0.2 (Ref # 8A)	92025-518	AR
SHIM,T=0.3 (Ref # 8B)	92025-523	AR
SHIM,T=0.4 (Ref # 8C)	92025-527	AR
SHIM,T=0.5 (Ref # 8D)	92025-530	AR
SHIM,T=0.6 (Ref # 8E)	92025-533	AR
SHIM,T=0.1 (Ref # 8)	92025-513	AR
BEARING-BALL,6206NC3 (Ref # 9)	92045-505	2