

1988 JS440 PARTS DIAGRAM

Cylinder Head/Cylinder

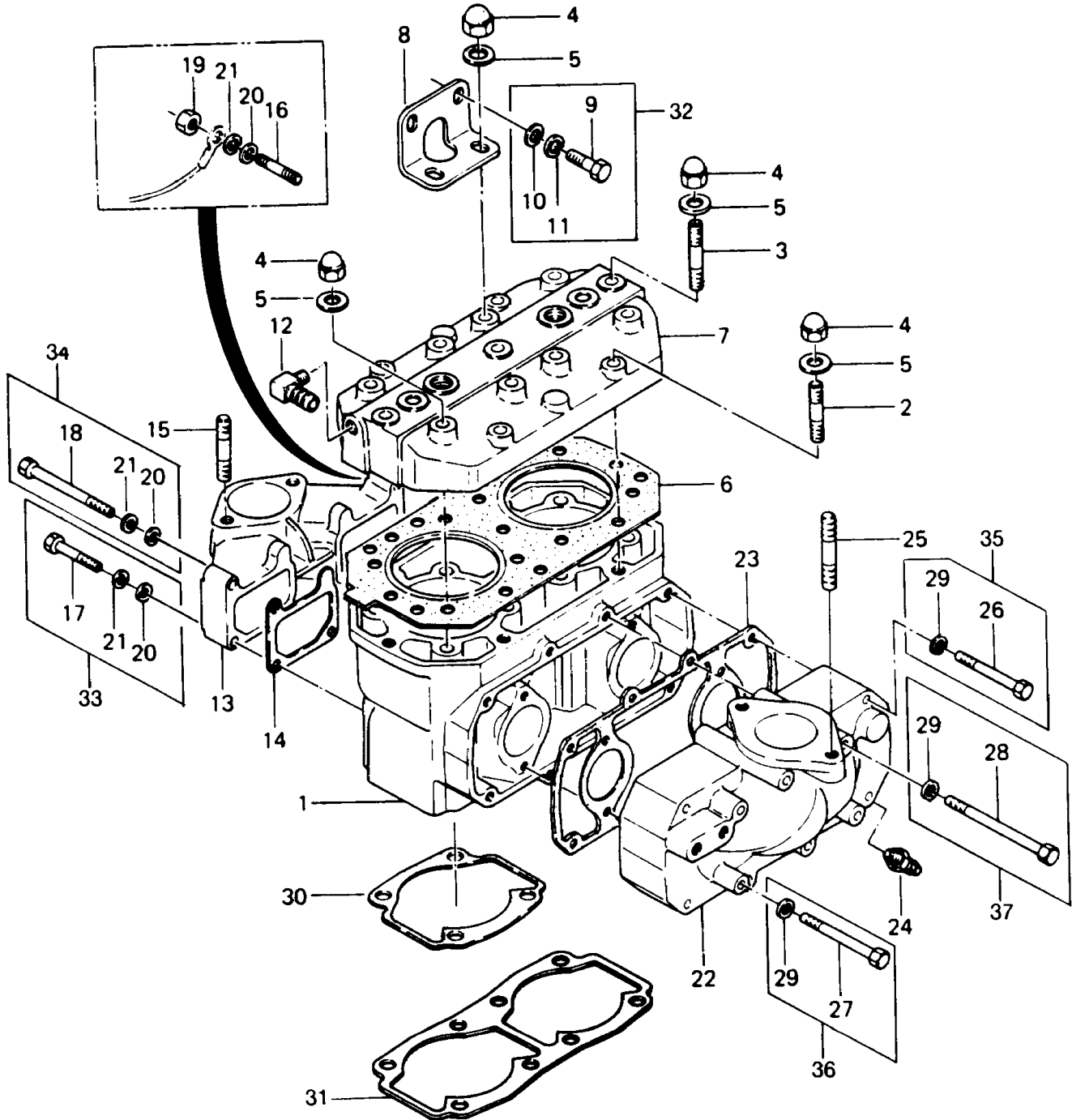

1988 JS440 PARTS LIST

Cylinder Head/Cylinder

ITEM NAME	PART NUMBER	QUANTITY
WASHER-PLAIN,6MM (Ref # 10)	411S0600	2
WASHER-SPRING,6MM (Ref # 11)	461S0600	2
ELBOW (Ref # 12)	52014-3002	1
MANIFOLD-INTAKE (Ref # 13)	59076-505-YR	1
GASKET,INTAKE (Ref # 14)	16062-510	2
BOLT-STUD,8X35 (Ref # 15)	172R0835	2
BOLT-STUD,6X35 (Ref # 16)	171R0635	1
BOLT,6X35 (Ref # 17)	110R0635	3
BOLT,6X70 (Ref # 18)	110R0670	2
NUT-HEX,6MM (Ref # 19)	311R0600	1
WASHER-PLAIN-SMALL,6MM (Ref # 20)	410S0600	6
WASHER-SPRING,6MM (Ref # 21)	461S0600	6
MANIFOLD-EXHAUST (Ref # 22)	59081-504-YR	1
GASKET,EXHAUST MANIFOLD (Ref # 23)	11009-3023	1
FITTING,HOSE (Ref # 24)	92005-3001	1
BOLT-STUD,8X35 (Ref # 25)	172R0835	2
BOLT,6X50 (Ref # 26)	110R0650	6
BOLT,6X70 (Ref # 27)	110R0670	4
BOLT,6X85 (Ref # 28)	110R0685	2
WASHER-PLAIN-SMALL,6MM (Ref # 29)	410S0600	12
GASKET,CYLINDER (Ref # 30)	11009-505	2
CYLINDER-ENGINE (Ref # 1)	11005-3025-YR	1
STUD,8X42 (Ref # 2)	92004-3016	4
STUD,8X50 (Ref # 3)	92004-3017	3
NUT,CAP,8MM (Ref # 4)	92015-3003	15
WASHER-PLAIN,8MM (Ref # 5)	411S0800	15
GASKET-HEAD (Ref # 6)	11004-3019	1
HEAD-COMP-CYLINDER (Ref # 7)	11008-3002-YR	1
BRACKET (Ref # 8)	11034-3011	1