

1987 Bayou 300 PARTS DIAGRAM

OWNER TOOLS

F2810-0216

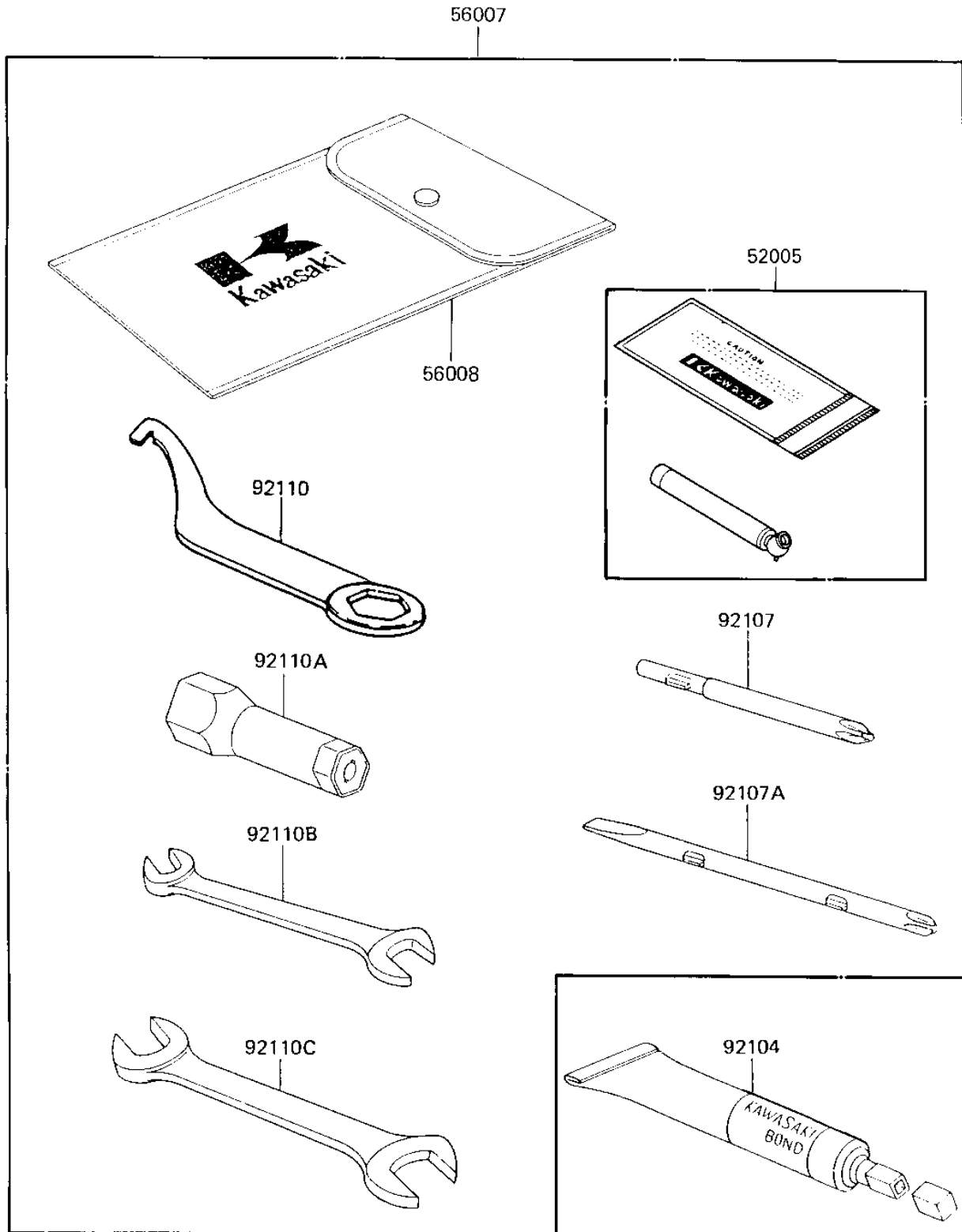

1987 Bayou 300 PARTS LIST

OWNER TOOLS

ITEM NAME	PART NUMBER	QUANTITY
GAUGE,AIR (Ref # 52005)	52005-1082	1
TOOLKIT (Ref # 56007)	56007-1307	1
BAG,TOOL (Ref # 56008)	56008-1007	1
LIQUID GASKET (Ref # 92104)	92104-002	1
SCREW DRIVER #3 PHLIP (Ref # 92107)	92107-005	1
92107-1052 (Canada) (Ref # 92107A)	92107-1051	1
TOOL-WRENCH,HOOK&BOXE (Ref # 92110)	92110-1040	1
TOOL-WRENCH (Ref # 92110A)	92110-1113	1
TOOL-WRENCH,OPEN END, (Ref # 92110B)	92110-1152	1
TOOL-WRENCH,OPEN END, (Ref # 92110C)	92110-1153	1