

# 1984 JS440 PARTS DIAGRAM

CRANKCASE ('84-'86 JS440-A8/A9/A10)

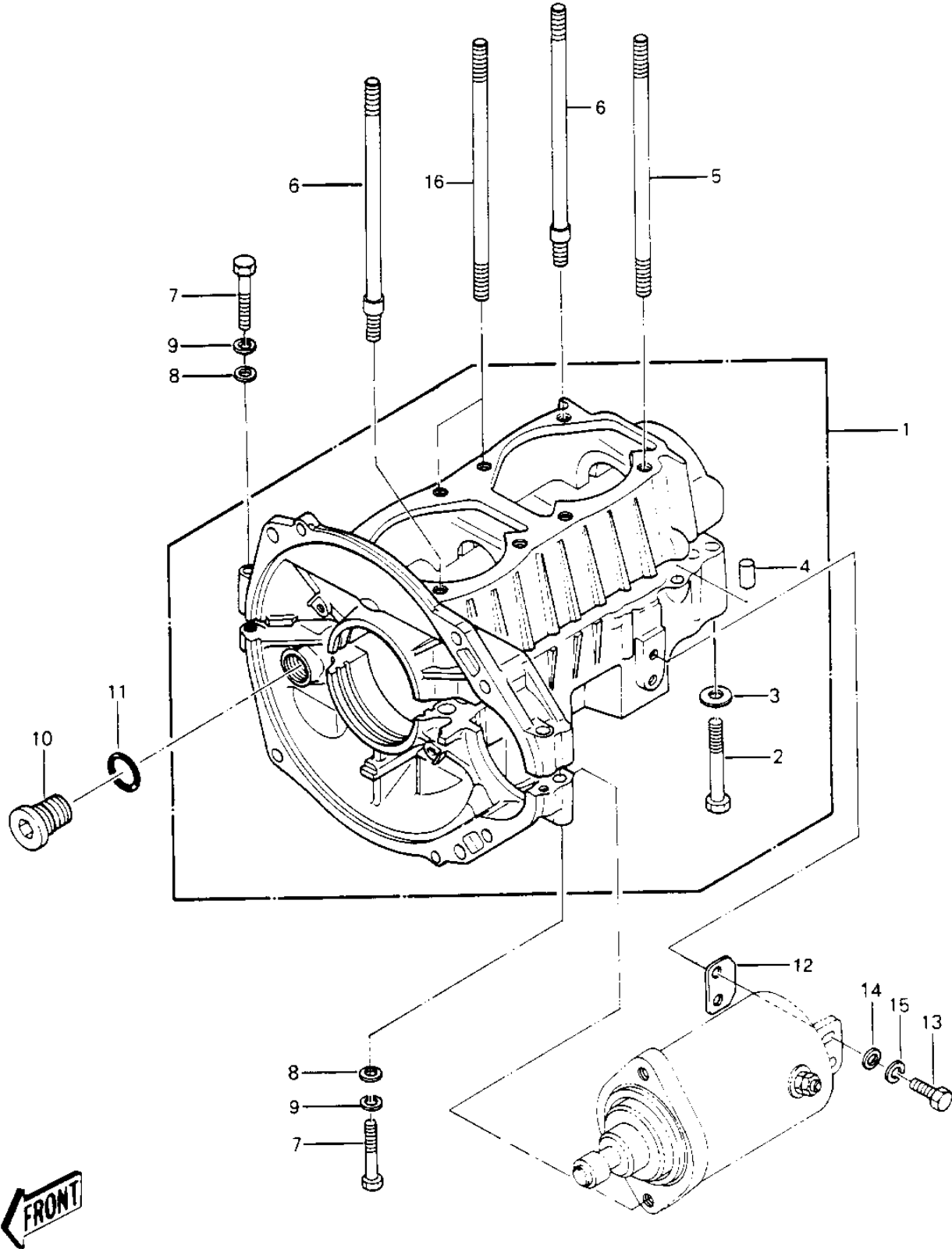

# 1984 JS440 PARTS LIST

CRANKCASE ('84-'86 JS440-A8/A9/A10)

ITEM NAME	PART NUMBER	QUANTITY
SET-CRANKCASE (Ref # 1)	14001-5265	1
BOLT,8X60 (Ref # 2)	92001-3033	10
WASHER (Ref # 3)	410S0800	10
PIN-DOWEL (Ref # 4)	92042-007	2
STUD (Ref # 5)	92004-507	4
STUD,8X167 (Ref # 6)	92004-3020	2
BOLT 6X40 (Ref # 7)	110R0640	3
WASHER (Ref # 8)	410S0600	3
WASHER-SPRING,6MM (Ref # 9)	461S0600	3
JOINT-STATOR WIRE (Ref # 10)	59071-516	1
"0" RING,16MM (Ref # 11)	670B2016	1
SHIM,STARTER,T=0.4M/M (Ref # 12)	92025-3012	AR
SHIM,STARTER,T=0.6M/M (Ref # 12)	92025-3013	AR
SHIM,STARTER,T=0.8M/M (Ref # 12)	92025-3014	AR
BOLT 6X20 (Ref # 13)	110R0620	2
WASHER (Ref # 14)	410S0600	2
WASHER-SPRING,6MM (Ref # 15)	461S0600	2
STUD,8X170 (Ref # 16)	92004-2084	2