

1991 300 SX PARTS DIAGRAM

Starter Motor(JS300-A3/A4/A5)

E1840B

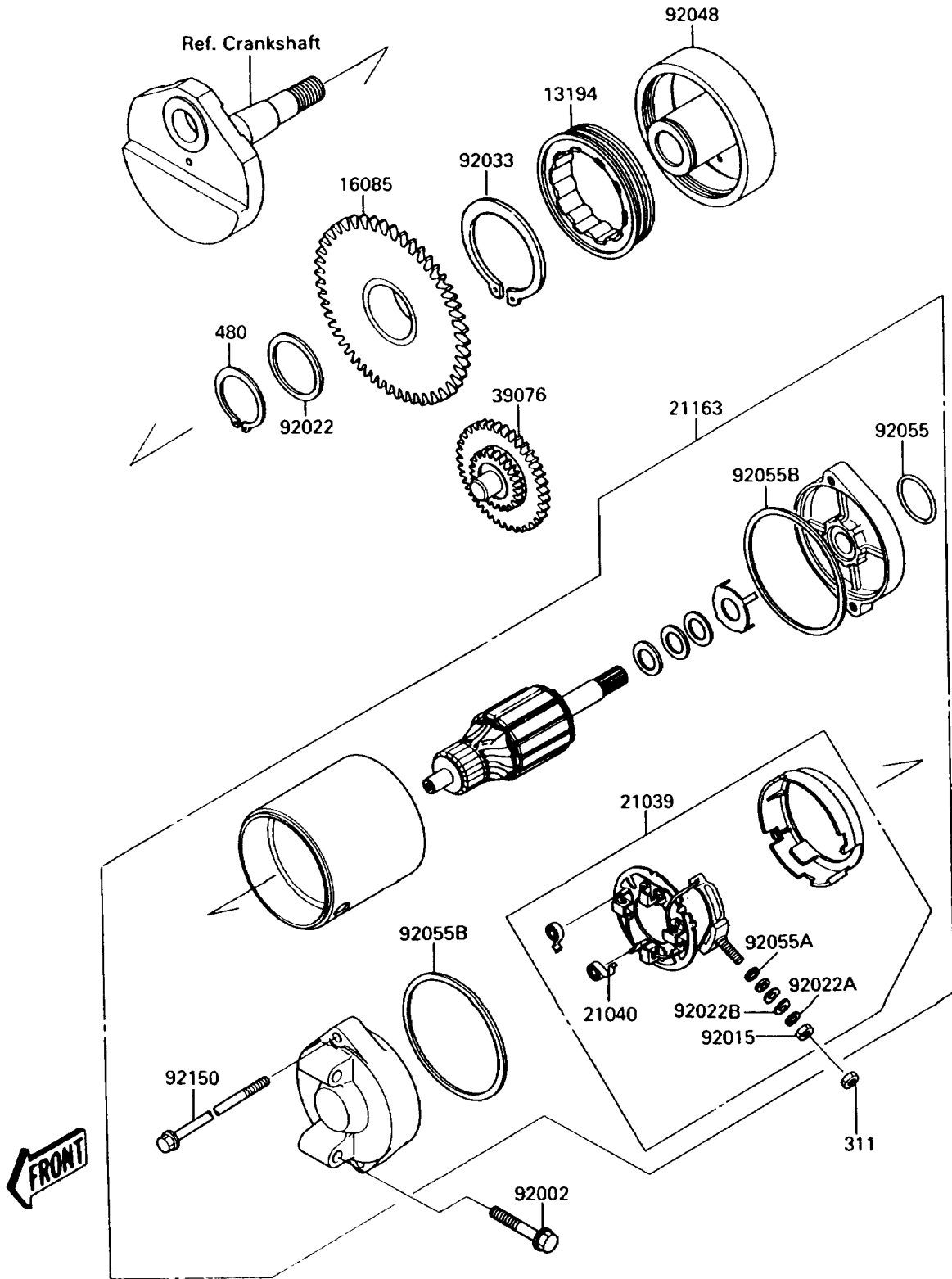

1991 300 SX PARTS LIST

Starter Motor(JS300-A3/A4/A5)

ITEM NAME	PART NUMBER	QUANTITY
CLUTCH-ONEWAY (Ref # 13194)	13194-3703	1
GEAR,STARTER,59T (Ref # 16085)	16085-3701	1
BRUSH,CARBON (Ref # 21039)	21039-3703	1
SPRING-BRUSH (Ref # 21040)	21040-1055	1
STARTER-ELECTRIC (Ref # 21163)	21163-3708	1
LIMITER,STARTER IDLE (Ref # 39076)	39076-3701	1
BOLT,6X35 (Ref # 92002)	92002-3715	1
NUT,6MM (Ref # 92015)	92015-3710	1
WASHER,36.3X46X2 (Ref # 92022)	92022-1102	1
WASHER,6MM (Ref # 92022A)	92022-3711	1
WASHER,6MM (Ref # 92022B)	92022-3713	1
RING,SNAP (Ref # 92033)	92033-3076	1
RACE,CLUTCH (Ref # 92048)	92048-3706	1
RING-O (Ref # 92055)	92055-1276	1
RING-O,4.5X2.0 (Ref # 92055A)	92055-1370	1
RING-O,STARTER MOTOR (Ref # 92055B)	92055-1381	1
BOLT,STARTER MOTOR (Ref # 92150)	92150-3774	1
NUT-HEX,6MM (Ref # 311)	311R0600	1
CIRCLIP-TYPE-C,36MM (Ref # 480)	480J3600	1