

1983 JS440 PARTS DIAGRAM

ELECTRIC CASE ('82-'83 JS440-A6/A7)

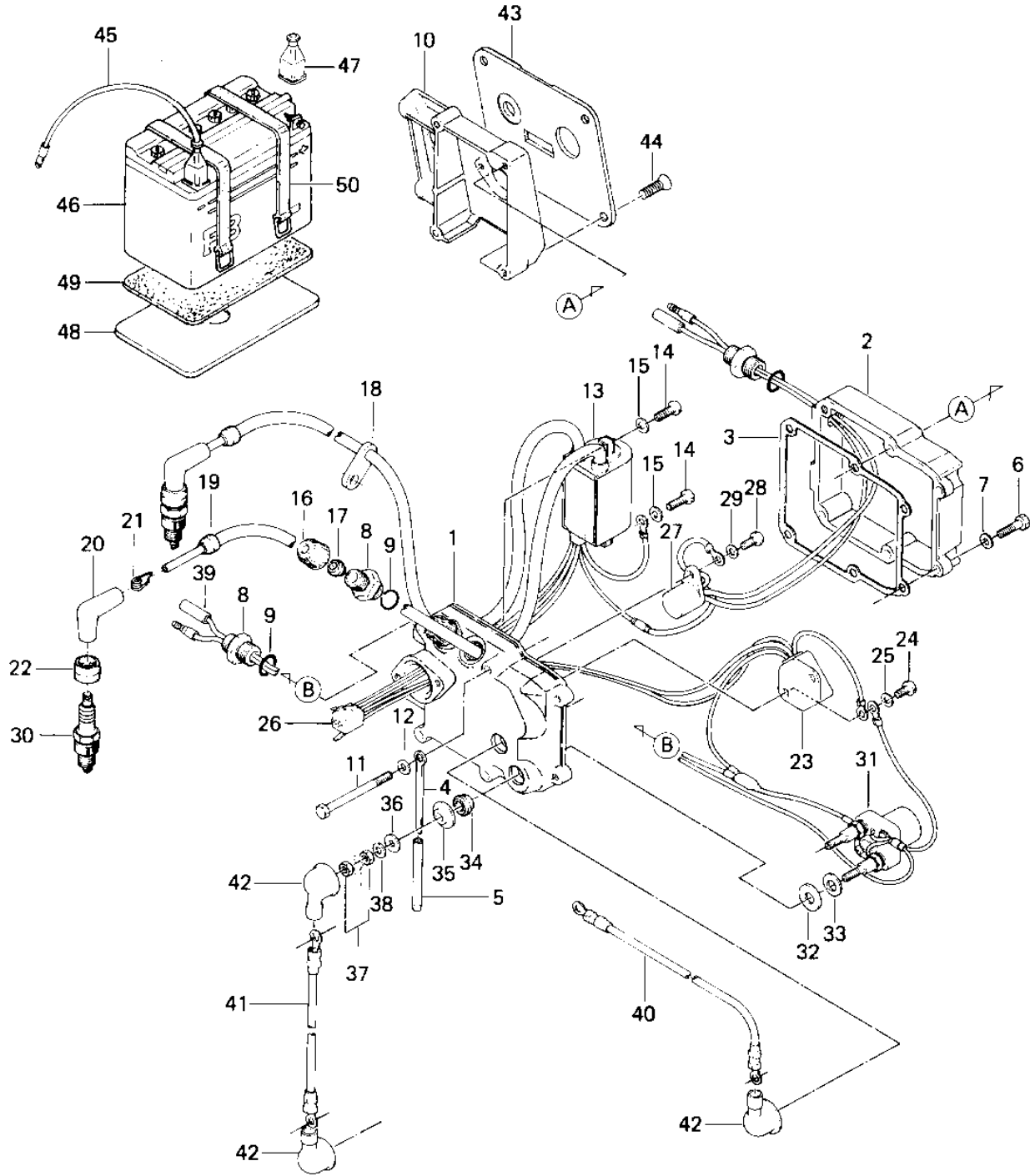

1983 JS440 PARTS LIST

ELECTRIC CASE ('82-'83 JS440-A6/A7)

ITEM NAME	PART NUMBER	QUANTITY
CASE-ELECTRIC,FRONT (Ref # 1)	59416-3004-YR	1
CASE-ELECTRIC,REAR (Ref # 2)	59416-3003-YR	1
GASKET,ELECTRIC CASE (Ref # 3)	11009-3781	1
CLAMP,L=100 (Ref # 4)	92037-3736	1
TUBE,VINYL,5X73 (Ref # 5)	92059-3017	1
BOLT,HEX HEAD,6X25 (Ref # 6)	110R0625	2
UNAVAILABLE IN PRICE BOOK (Ref # 7)	411A0600	2
JOINT (Ref # 8)	59071-3001	4
"O" RING,16MM (Ref # 9)	670B2016	4
CASE,FUEL TAP (Ref # 10)	32099-3752	1
BOLT,6X80 (Ref # 11)	110R0680	4
WASHER (Ref # 12)	411S0600	4
IGNITER (Ref # 13)	21119-3016	1
SCREW PAN HEAD 6X20 (Ref # 14)	220B0620	2
WASHER PLAIN 6MM (Ref # 15)	410B0600	2
CAP (Ref # 16)	11012-3005	2
GROMMET (Ref # 17)	92071-527	2
GROMMET (Ref # 18)	92071-529	1
GROMMET (Ref # 19)	92071-517	2
CAP SPARK PLUG (Ref # 20)	21130-009	2
SPRING-SPARK PLUG CAP (Ref # 21)	92101-001	2
COVER,PLUG (Ref # 22)	92071-501	2
REGULATOR VOLTAGE (Ref # 23)	21066-3004	1
SCREW PAN HEAD 6X12 (Ref # 24)	220B0612	2
WASHER PLAIN 6MM (Ref # 25)	410B0600	2
CONNECTOR,CORD (Ref # 26)	59221-505	1
RELAY (Ref # 27)	27034-3002	1
SCREW PAN HEAD 6X16 (Ref # 28)	220B0616	1
WASHER PLAIN 6MM (Ref # 29)	410B0600	1

1983 JS440 PARTS LIST

ELECTRIC CASE ('82-'83 JS440-A6/A7)

ITEM NAME	PART NUMBER	QUANTITY
SPARK PLUG B7ES (Ref # 30)	92070-3003	2
SWITCH,SOLENOID (Ref # 31)	27010-3007	1
WASHER,10.5X24X2.5 (Ref # 32)	92022-3035	2
WASHER PLAIN 10MM (Ref # 33)	410B1000	2
GROMMET (Ref # 34)	92071-3004	2
WASHER (Ref # 35)	92022-3036	2
WASHER (Ref # 36)	92022-553	2
NUT,6M/M (Ref # 37)	311R0600	4
WASHER (Ref # 38)	411S0600	2
WIRE-LEAD,L=230 (Ref # 39)	26011-3003	1
WIRE-LEAD,BATTERY(+) (Ref # 40)	26011-3778	1
WIRE-LEAD,L=340 (Ref # 41)	26011-3005	1
CAP (Ref # 42)	11012-3004	3
PANEL-CONTROL (Ref # 43)	59226-3702	1
SCREW,CNTSNK HEAD8X22 (Ref # 44)	92009-3004	4
WIRE-LEAD,BATTERY(-) (Ref # 45)	26011-3776	1
FB BAT 12N16-3B (Ref # 46)	26012-1013	1
CAP-BATTERY TERMINAL (Ref # 47)	59176-501	2
UNAVAILABLE IN PRICE BOOK (Ref # 48)	13169-301	1
CUSHION,BATTERY (Ref # 49)	92075-509	1
BAND,BATTERY (Ref # 50)	92072-512	2