

1989 300 SX PARTS DIAGRAM

Crankcase

(E1411)

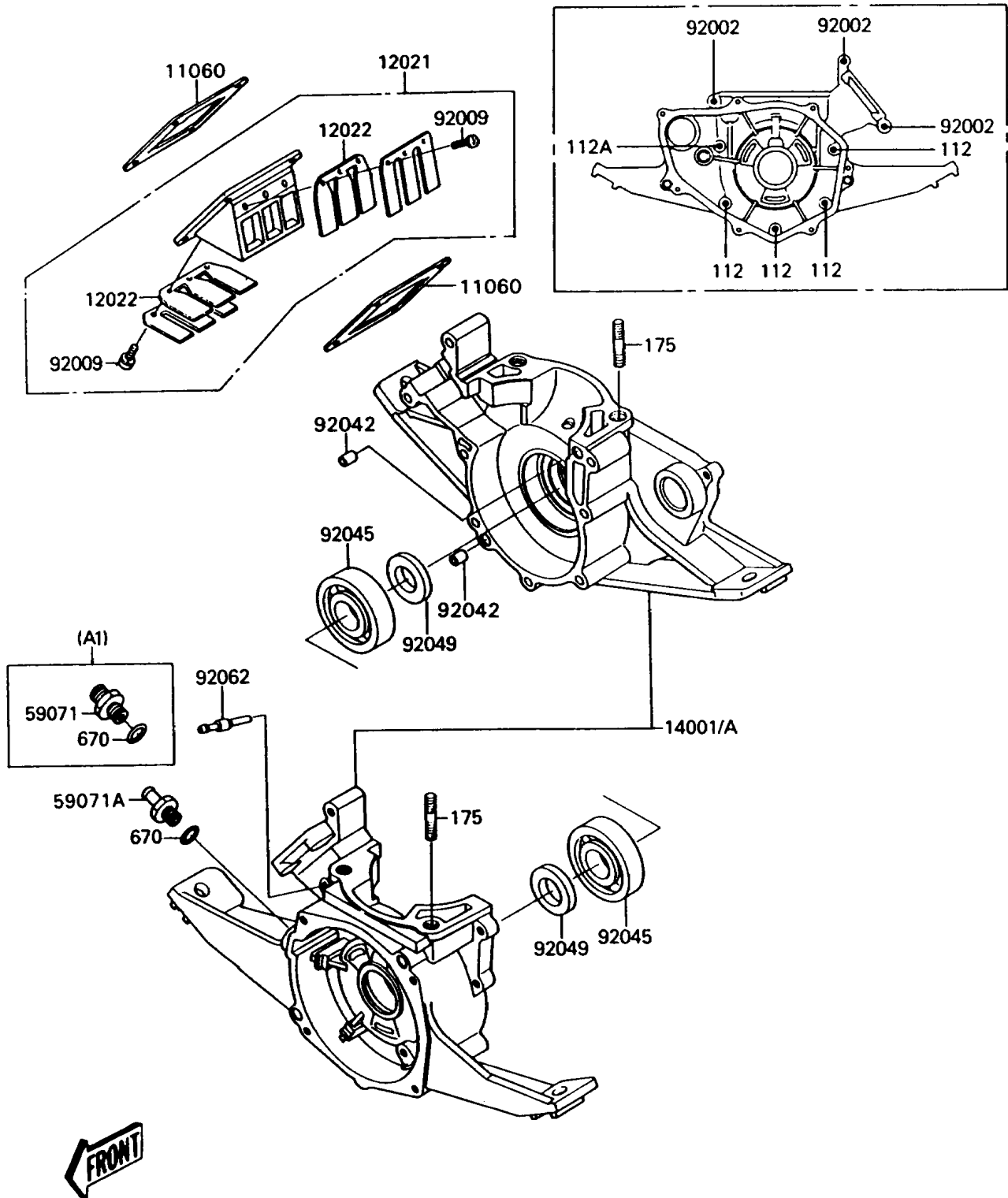

1989 300 SX PARTS LIST

Crankcase

ITEM NAME	PART NUMBER	QUANTITY
GASKET, REED VALVE (Ref # 11060)	11060-3703	2
VALVE-ASSY-REED (Ref # 12021)	12021-1007	1
VALVE-REED (Ref # 12022)	12022-1001	2
SET-CRANKCASE (Ref # 14001)	14001-5199	1
JOINT (Ref # 59071A)	59071-3718	1
BOLT, 6X45 (Ref # 92002)	92002-3717	3
SCREW, REED VALVE (Ref # 92009)	92009-1014	6
PIN, DOWEL, 6.3X8X14 (Ref # 92042)	92042-007	2
BEARING-BALL, 6305JR2C3 (Ref # 92045)	92045-1120	2
SEAL-OIL (Ref # 92049)	92049-1047	2
NOZZLE (Ref # 92062)	92062-3703	1
BOLT-UPSET (Ref # 112)	112H0645	4
BOLT-UPSET (Ref # 112A)	112H0665	1
BOLT-STUD-FINE (Ref # 175)	175R1035	4
O RING, 16MM (Ref # 670)	670B2016	1