

1986 ZL600 Eliminator PARTS DIAGRAM

GEAR CHANGE MECHANISM

E1370-0164

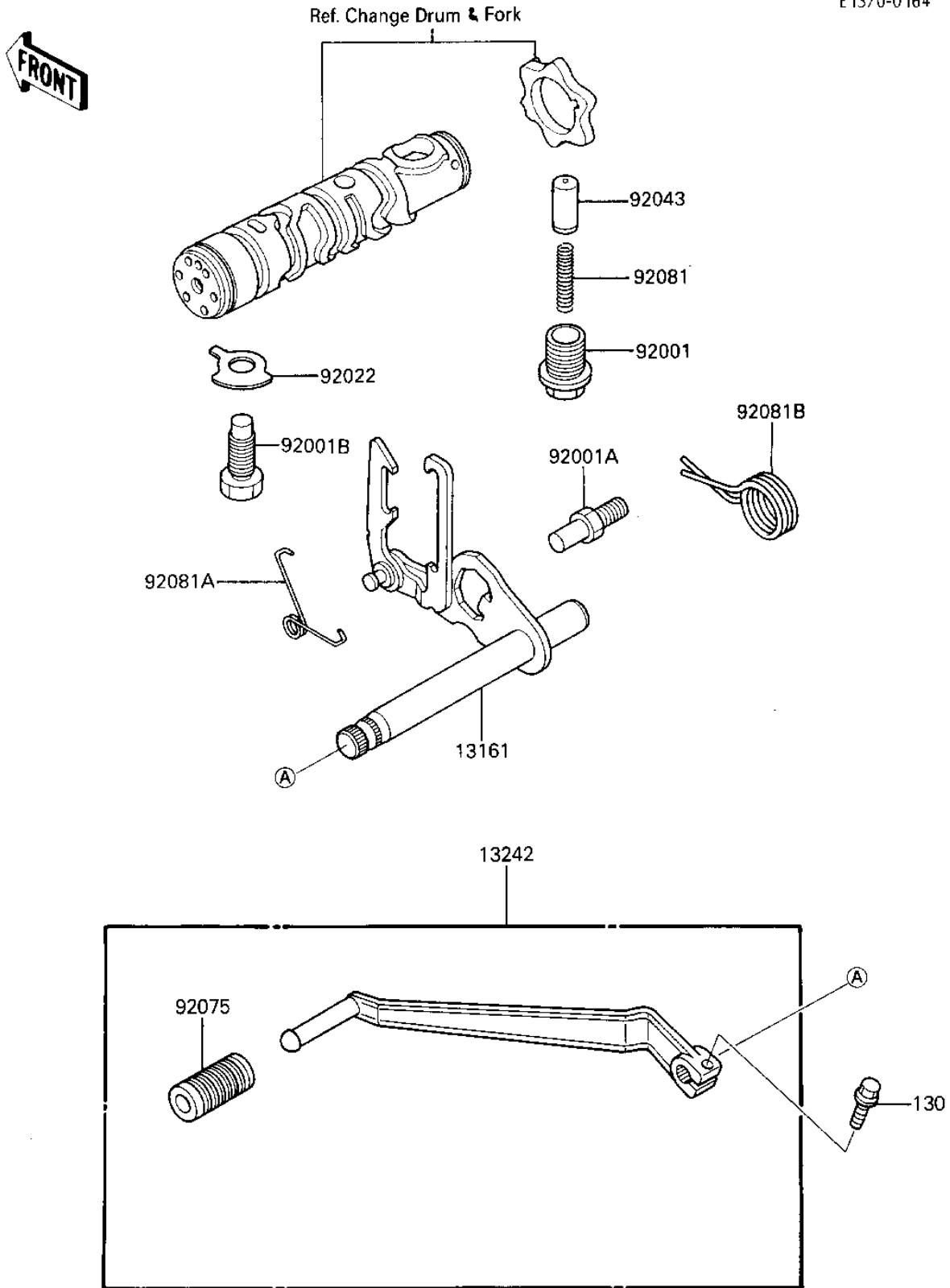

1986 ZL600 Eliminator PARTS LIST

GEAR CHANGE MECHANISM

ITEM NAME	PART NUMBER	QUANTITY
LEVER ASSY,GEAR SFT (Ref # 13161)	13161-042	1
LEVER-ASSY-CHANGE,PED (Ref # 13242)	13242-1269	1
BOLT,NEUTRAL POSITION (Ref # 92001)	92001-1037	1
BOLT,RETURN SPRING (Ref # 92001A)	92001-1401	1
BOLT,HEX HEAD,10X26 (Ref # 92001B)	92001-174	1
WASHER,LOCK,10MM (Ref # 92022)	92024-074	1
PIN-NEUTRAL POSITION (Ref # 92043)	92043-076	1
RUBBER CHANGE PEDAL (Ref # 92075)	13157-004	1
SPRING (Ref # 92081)	92081-112	1
SPRING,KICK PAWL (Ref # 92081A)	92083-018	1
SPRING,CHG PEDL RTRN (Ref # 92081B)	92083-028	1
BOLT-FLANGED,6X20,BLA (Ref # 130)	130S0620	1