

1987 KLT185 PARTS DIAGRAM

TRANSMISSION

E1361-0155

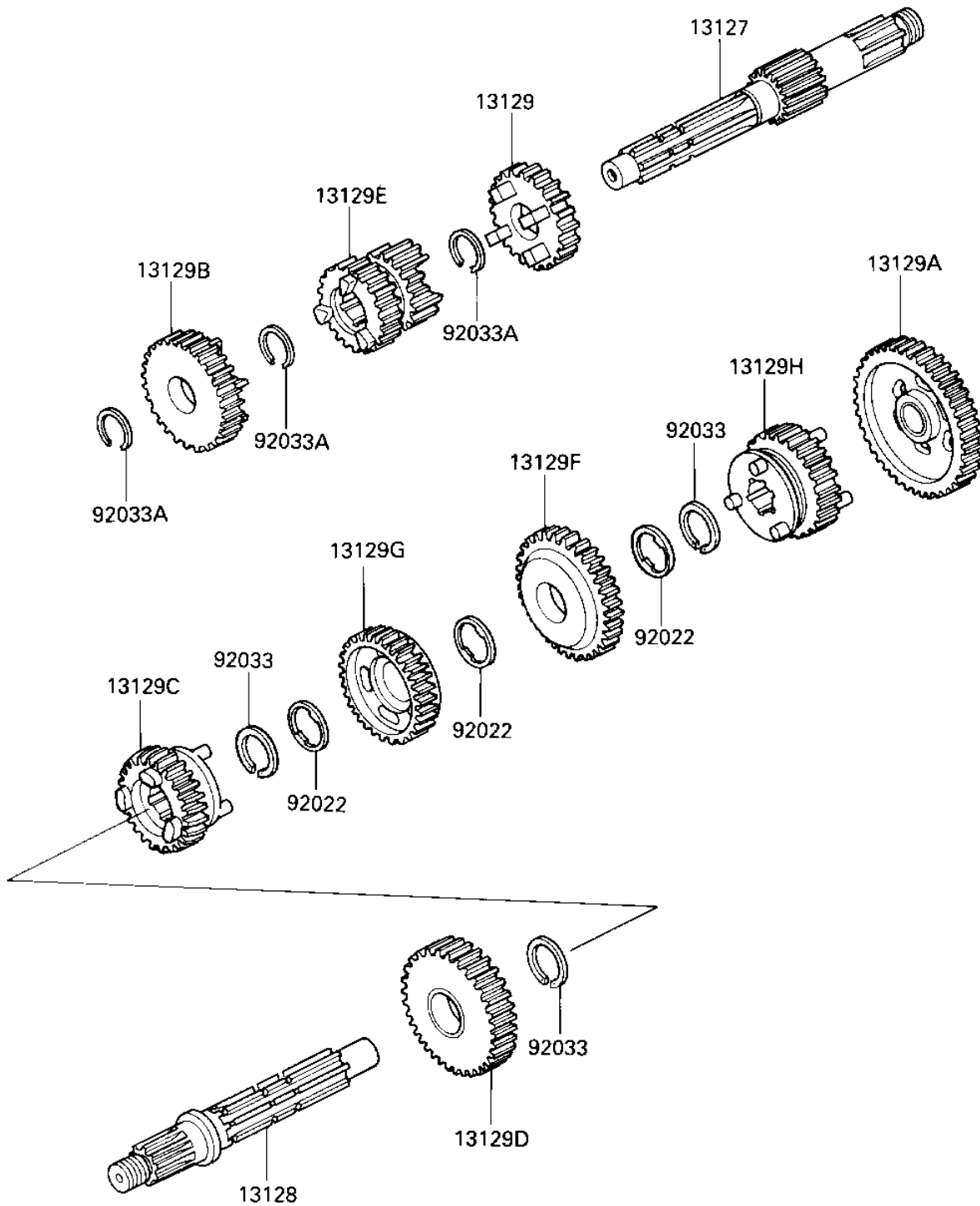

1987 KLT185 PARTS LIST

TRANSMISSION

ITEM NAME	PART NUMBER	QUANTITY
SHAFT-TRANSMISSION IN (Ref # 13127)	13127-1109	1
SHAFT-TRANSMISSION OU (Ref # 13128)	13128-1122	1
GEAR,INPUT 4TH,26T (Ref # 13129)	13129-1541	1
GEAR,OUTPUT LOW,40T (Ref # 13129A)	13129-1543	1
GEAR,INPUT TOP,28T (Ref # 13129B)	13129-1674	1
GEAR-TRANSMISSION SPU (Ref # 13129C)	13129-1690	1
GEAR-TRANSMISSION SPU (Ref # 13129D)	13129-1691	1
GEAR-TRANSMISSION SPU (Ref # 13129E)	13129-1696	1
GEAR-TRANSMISSION SPU (Ref # 13129F)	13129-1697	1
GEAR-TRANSMISSION SPU (Ref # 13129G)	13129-1698	1
GEAR-TRANSMISSION SPU (Ref # 13129H)	13129-1699	1
WASHER-PLAIN (Ref # 92022)	92022-198	3
CIRCLIP,25MM (Ref # 92033)	92033-025	3
CIRCLIP (Ref # 92033A)	92033-028	3