

1986 X2 PARTS DIAGRAM

HULL (JF650-A1)

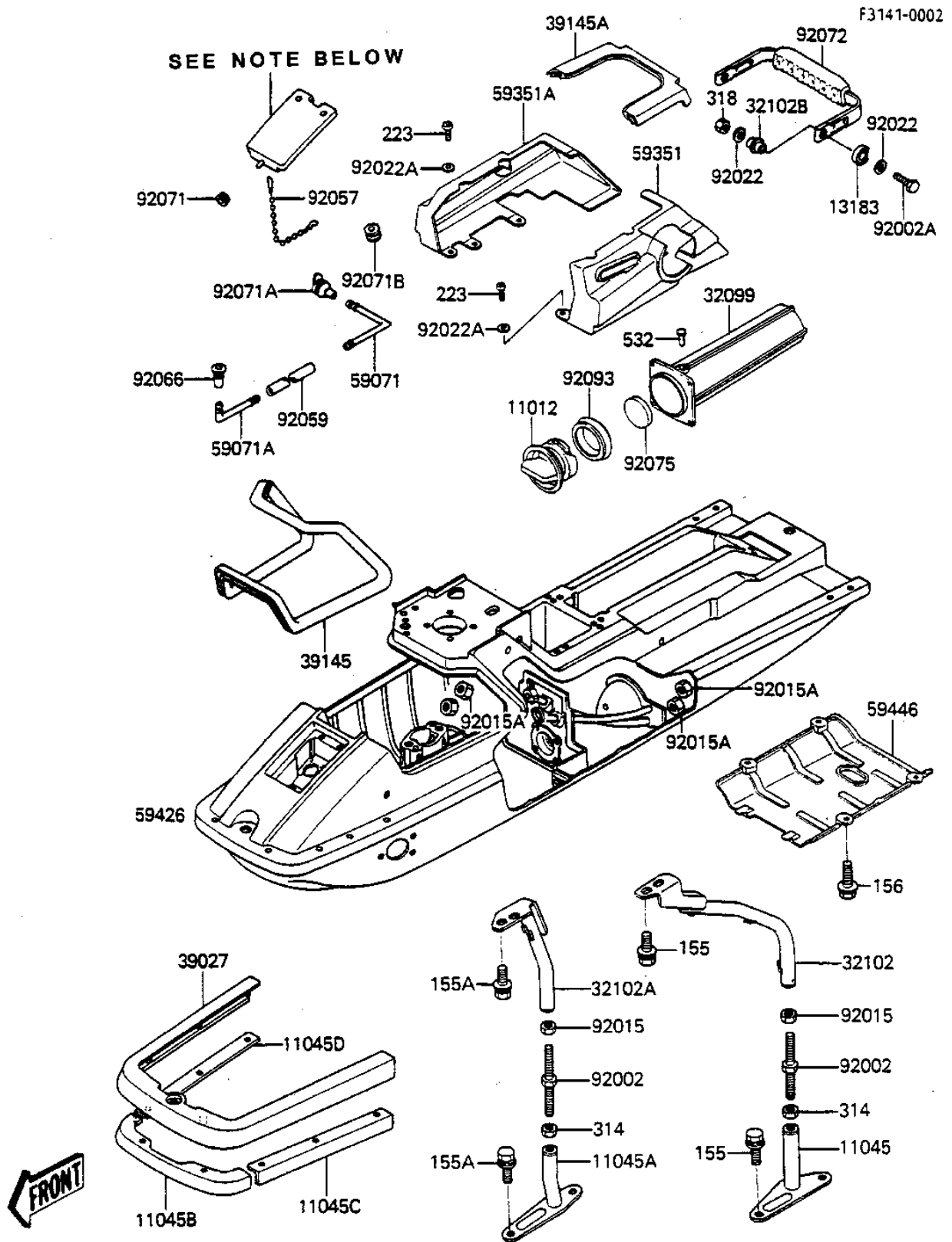

1986 X2 PARTS LIST

HULL (JF650-A1)

| ITEM NAME | PART NUMBER | QUANTITY |
|-------------------------------------|---------------|----------|
| CAP,FIRE EXT (Ref # 11012) | 11012-3708 | 1 |
| BRACKET,DECK,LH (Ref # 11045) | 11044-3710 | 1 |
| BRACKET,DECK,RH (Ref # 11045A) | 11044-3711 | 1 |
| BRACKET,BUMPER,CNT (Ref # 11045B) | 11045-3710 | 1 |
| BRACKET,BUMPER,LH (Ref # 11045C) | 11045-3711 | 1 |
| BRACKET,BUMPER,RH (Ref # 11045D) | 11045-3712 | 1 |
| PLATE (Ref # 13183) | 13169-3714 | 2 |
| COVER-TANK CAP,JET WT (Ref # 14024) | 14024-3710-8C | 1 |
| CASE,FIRE EXT (Ref # 32099) | 32099-3705 | 1 |
| PIPE,DECK,LH (Ref # 32102) | 32033-3718 | 1 |
| PIPE,DECK,RH (Ref # 32102A) | 32033-3719 | 1 |
| PIPE (Ref # 32102B) | 32102-3704 | 2 |
| BUMPER-FRONT (Ref # 39027) | 39027-3702 | 1 |
| TRIM-SEAL (Ref # 39145) | 39145-3701 | 1 |
| TRIM-SEAL,DECK (Ref # 39145A) | 39145-3702 | 1 |
| JOINT (Ref # 59071) | 59071-3706 | 1 |
| JOINT (Ref # 59071A) | 59071-3714 | 1 |
| DECK,LH (Ref # 59351) | 59351-3708-8C | 1 |
| DECK,RH (Ref # 59351A) | 59351-3709-8C | 1 |
| HULL,COMP,JF650A,J,WT (Ref # 59426) | 59426-5512-8C | 1 |
| COVER-JET PUMP (Ref # 59446) | 59446-3703 | 1 |
| BOLT,10MM (Ref # 92002) | 92002-3731 | 2 |
| BOLT,8X30 (Ref # 92002A) | 92002-3742 | 2 |
| NUT,10MM (Ref # 92015) | 92015-3737 | 2 |
| NUT,20MM (Ref # 92015A) | 92015-3738 | 4 |
| WASHER,8.5X19X1.2 (Ref # 92022) | 92022-3730 | 4 |
| WASHER (Ref # 92022A) | 92022-567 | 8 |
| CHAIN,COVER (Ref # 92057) | 92057-3701 | 1 |
| TUBE,5.8X250 (Ref # 92059) | 92059-3765 | 1 |

1986 X2 PARTS LIST

HULL (JF650-A1)

| ITEM NAME | PART NUMBER | QUANTITY |
|-----------------------------------|-------------|----------|
| PLUG (Ref # 92066) | 92066-3706 | 1 |
| GROMMET (Ref # 92071) | 92071-3733 | 1 |
| GROMMET (Ref # 92071A) | 92071-3736 | 1 |
| GROMMET (Ref # 92071B) | 92071-3737 | 2 |
| BAND,TANDEM (Ref # 92072) | 92072-3711 | 1 |
| DAMPER (Ref # 92075) | 92075-3719 | 1 |
| SEAL (Ref # 92093) | 92093-3704 | 1 |
| BOLT-WSP-SMALL,8X16 (Ref # 155) | 155R0816 | 4 |
| BOLT-WSP-SMALL,8X18 (Ref # 155A) | 155R0818 | 4 |
| BOLT-WP,6X22 (Ref # 156) | 156R0622 | 4 |
| SCREW-PAN-WS-CROS,6X2 (Ref # 223) | 223R0620 | 8 |
| NUT-HEX-FINE,10MM (Ref # 314) | 314R1000 | 2 |
| NUT-HEX-SMALL (Ref # 318) | 318R0800 | 2 |
| RIVET-FLAT (Ref # 532) | 532R0508 | 2 |