

1985 KD80 PARTS DIAGRAM

IGNITION/GENERATOR

E1810-0033

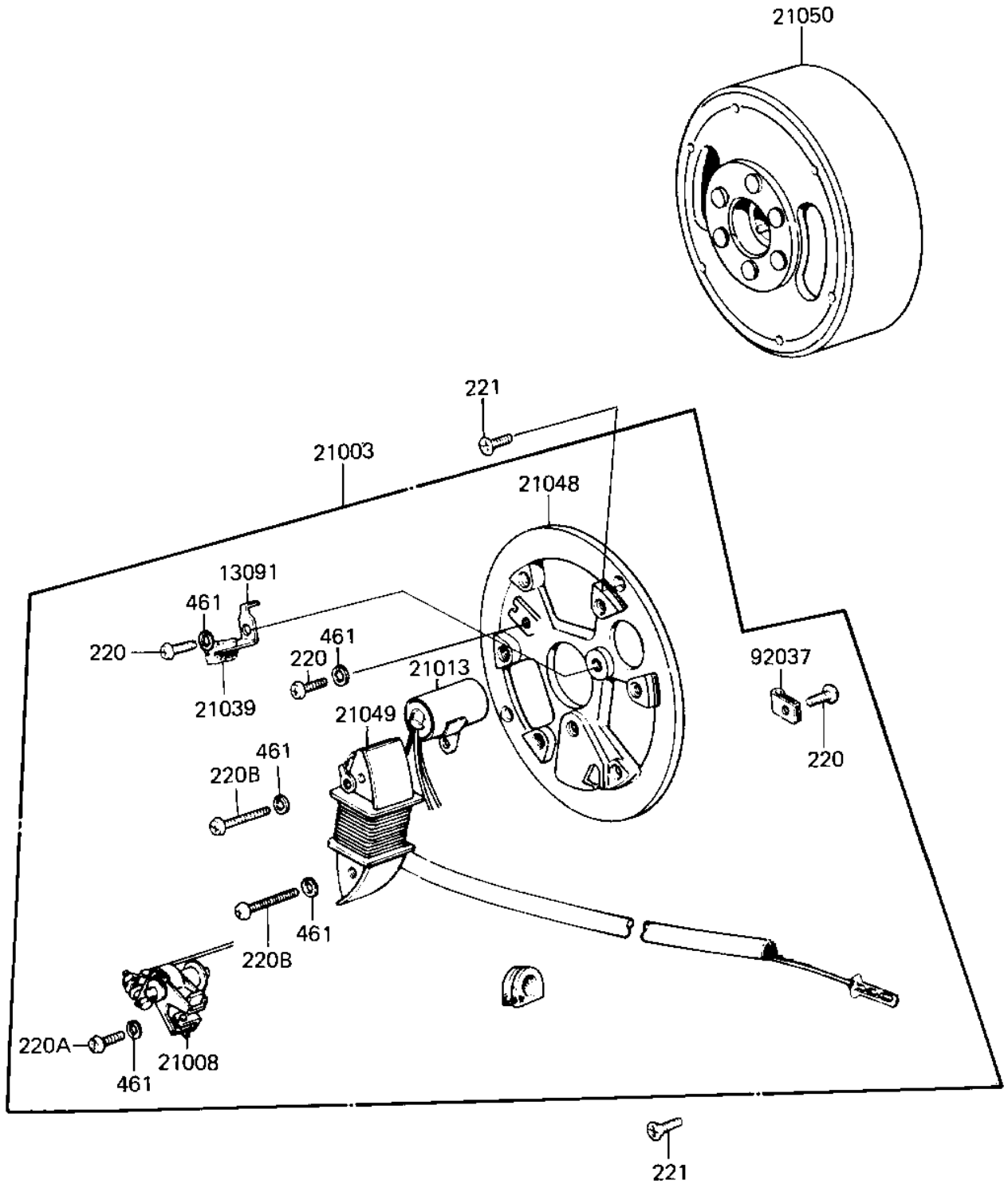

1985 KD80 PARTS LIST

IGNITION/GENERATOR

ITEM NAME	PART NUMBER	QUANTITY
HOLDER,OIL FELT (Ref # 13091)	21038-002	1
STATOR ASSY (Ref # 21003)	21003-1030	1
BREAKER ASSY CONTACT (Ref # 21008)	21008-006	1
CONDENSER (Ref # 21013)	21013-006	1
FELT OIL (Ref # 21039)	21019-005	1
PLATE-COIL,MAGNETO (Ref # 21048)	21048-1002	1
COIL,EXCITING (Ref # 21049)	21049-1004	1
FLYWHEEL,MAGNETO (Ref # 21050)	21050-1008	1
CLAMP WIRING HARNESS (Ref # 92037)	21037-002	1
SCREW PAN HEAD 4X6 (Ref # 220)	220B0406	1
SCREW-PAN-CRSOSS,4X12 (Ref # 220A)	220B0412	1
SCREW PAN HEAD 4X30 (Ref # 220B)	220E0430	1
SCREW CNTSNK HD 6X14 (Ref # 221)	221B0614	1
WASHER SPRING 4MM (Ref # 461)	461F0400	1