

1982 KD80 PARTS DIAGRAM

CARBURETOR

E1611-0045

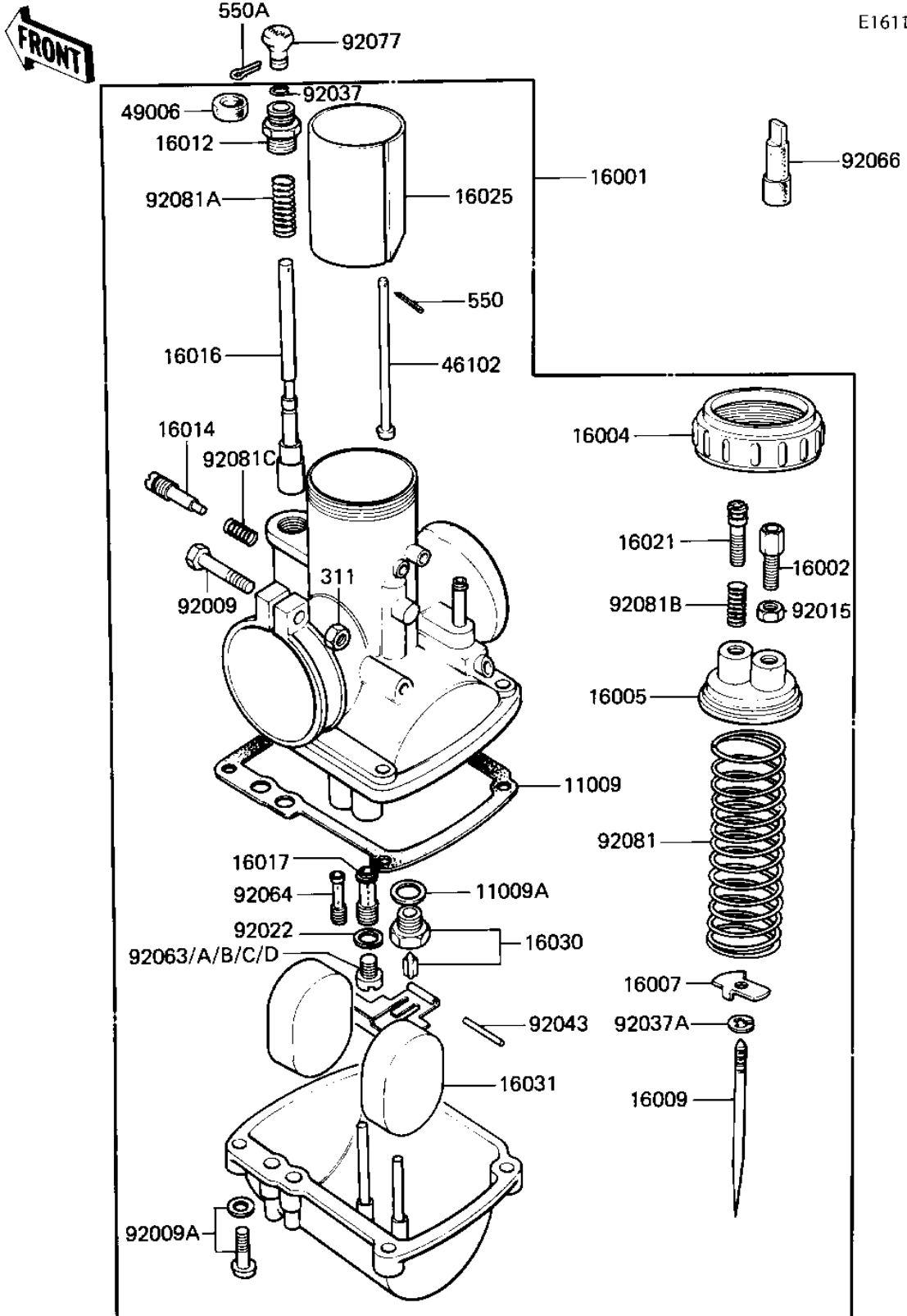

1982 KD80 PARTS LIST

CARBURETOR

ITEM NAME	PART NUMBER	QUANTITY
GASKET,FLOAT CHAMBER (Ref # 11009)	16019-021	1
WASHER VALVE SEAT (Ref # 11009A)	16029-002	1
CARBURETOR ASSY (Ref # 16001)	16001-251	1
ADJUSTER,CABLE (Ref # 16002)	16002-017	1
CAP MIXING CHAMBER (Ref # 16004)	16004-010	1
TOP MIXING CHAMBER (Ref # 16005)	16005-005	1
SPRING SEAT,THRTL TL (Ref # 16007)	16007-020	1
JET NEEDLE 4EJ7 (Ref # 16009)	16009-059	1
CAP STARTER PLUNGER (Ref # 16012)	16012-010	1
SCREW PILOT AIR ADJST (Ref # 16014)	16014-002	1
PLUNGER,STARTER (Ref # 16016)	16016-012	1
NEEDLE JET 0-6 (Ref # 16017)	16017-089	1
SCREW,THROTTLE STOP (Ref # 16021)	16021-002	1
VALVE,THROTTLE CA2.0 (Ref # 16025)	16025-057	1
FLOAT VALVE ASSY (Ref # 16030)	16030-009	1
FLOAT (Ref # 16031)	16031-015	1
ROD,THROTTLE VLV STP (Ref # 46102)	16024-012	1
CAP,STARTER PLUNGER (Ref # 49006)	16036-012	1
SCREW CLAMP (Ref # 92009)	16010-004	1
SCREW-FLOAT CHAMBER (Ref # 92009A)	16033-012	4
NUT CABLE ADJUST LOCK (Ref # 92015)	16003-004	1
WASHER MAIN JET (Ref # 92022)	16034-001	1
CIRCLIP (Ref # 92037)	92037-1077	1
CIRCLIP (Ref # 92037A)	16008-010	1
FLOAT PIN (Ref # 92043)	16032-003	1
MAIN JET NO 85R (Ref # 92063)	92063-093	1
MAIN JET,#77.5R (Ref # 92063A)	92063-1032	1
MAIN JET NO 75R (Ref # 92063B)	92063-109	1
MAIN JET, #A80 (Ref # 92063C)	92063-1030	1

1982 KD80 PARTS LIST

CARBURETOR

ITEM NAME	PART NUMBER	QUANTITY
MAIN JET NO 82.5R (Ref # 92063D)	92063-124	1
PILOT JET #17.5 ISO (Ref # 92064)	92064-020	1
PLUG,CARBURETOR CAP (Ref # 92066)	16147-001	1
KNOB,CARBURETOR (Ref # 92077)	92077-022	1
SPRING THROTTLE VALVE (Ref # 92081)	16006-013	1
SPRING,STARTER PLUNGR (Ref # 92081A)	16013-010	1
SPRING THR STOP SCREW (Ref # 92081B)	16022-005	1
SPRING, PILOT AIR SCREW (Ref # 92081C)	16022-007	1
NUT 6MM (Ref # 311)	311B0600	1
PIN COTTER 1.2X10 (Ref # 550)	550D1210	1
PIN COTTER 1.6X15 (Ref # 550A)	550D1615	1