

1982 KD80 PARTS DIAGRAM

CRANKCASE

E1411-0108

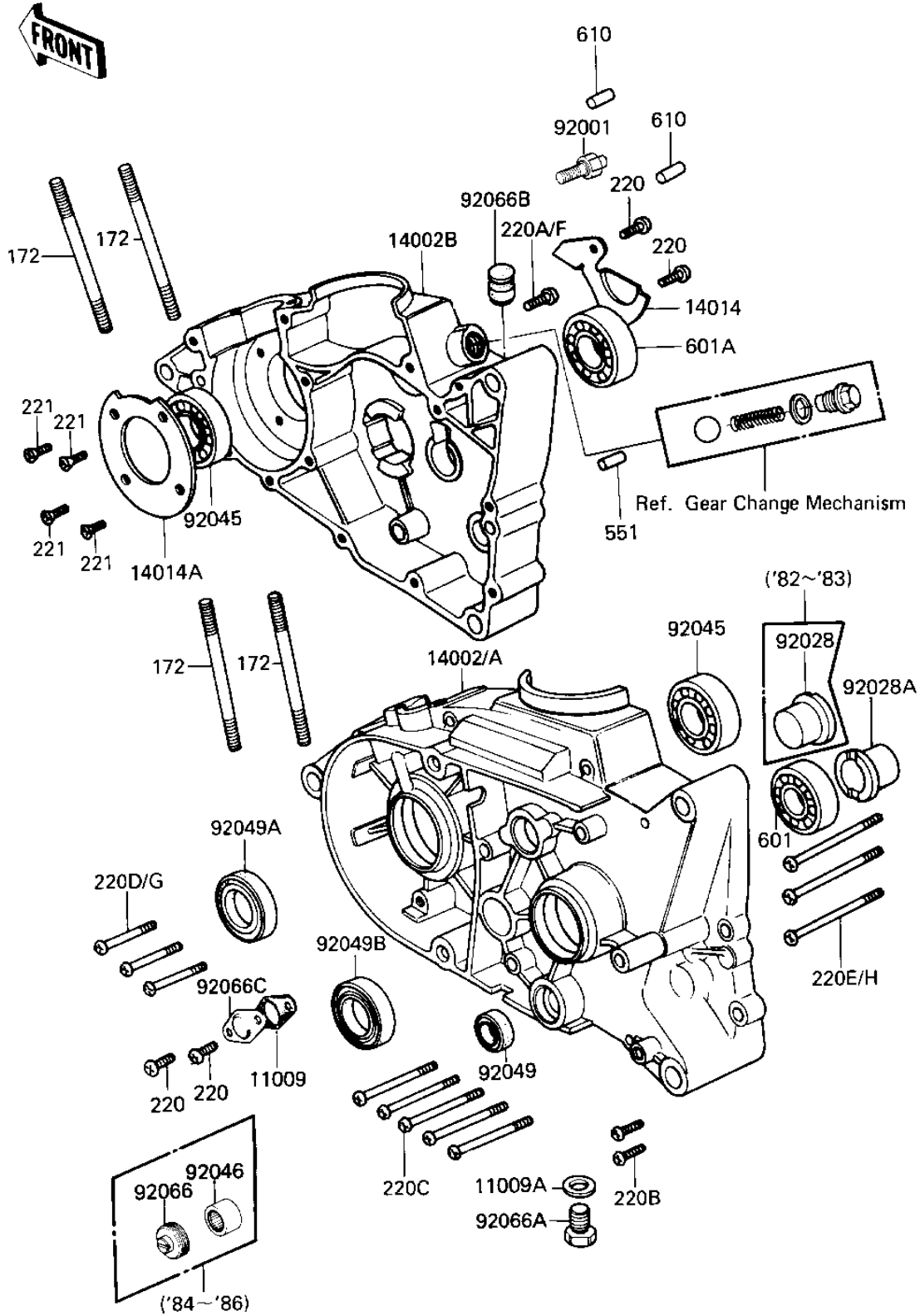

1982 KD80 PARTS LIST

CRANKCASE

ITEM NAME	PART NUMBER	QUANTITY
GASKET NEUTRAL SWITCH (Ref # 11009)	13146-002	1
GASKET CHECK VALVE (Ref # 11009A)	92065-058	1
CRANKCASE,L.H. (Ref # 14002)	14002-1072	1
CRANKCASE,RH (Ref # 14002B)	14002-1205	1
HOLDER BEARING MSSON (Ref # 14014)	14014-008	1
HOLDER CRANKSHAFT BRG (Ref # 14014A)	14014-017	1
BOLT,CRANK BRG HOLDER (Ref # 92001)	92001-1426	1
BUSH OUTPUT SHAFT (Ref # 92028)	92028-025	1
BUSH DRIVE SHAFT (Ref # 92028A)	92028-069	1
BEARING-BALL,#6204 (Ref # 92045)	92045-1032	2
OIL SEAL SB12205 (Ref # 92049)	92049-004	1
SEAL-OIL (Ref # 92049A)	92049-1240	1
OIL SEAL SC25376 (Ref # 92049B)	92050-013	1
PLUG OIL DRAIN (Ref # 92066A)	92067-001	1
RUBBER PLUG (Ref # 92066B)	92074-035	1
PLUG-OIL PUMP-HOLE (Ref # 92066C)	92084-004	1
STUD 8X115 (Ref # 172)	172G08115	4
SCREW PAN HEAD 6X12 (Ref # 220)	220B0612	4
SCREW PAN HEAD 6X20 (Ref # 220A)	220B0620	1
SCREW PAN HEAD 6X25 (Ref # 220B)	220B0625	2
SCREW PAN HEAD 6X40 (Ref # 220C)	220B0640	5
SCREW PAN HEAD 6X60 (Ref # 220D)	220B0660	3
SCREW PAN HEAD 6X65 (Ref # 220E)	220B0665	3
SCREW CNTSNK HD 6X16 (Ref # 221)	221B0616	4
PIN DOWEL 8X16 (Ref # 551)	551A0816	3
BEARING BALL #6004 (Ref # 601)	601B6004	1
BEARING BALL #6005 (Ref # 601A)	601B6005	1
PIN DOWEL 5X12 (Ref # 610)	610A0512	2