

1983 KD80 PARTS DIAGRAM

TRANSMISSION

E1361-0131

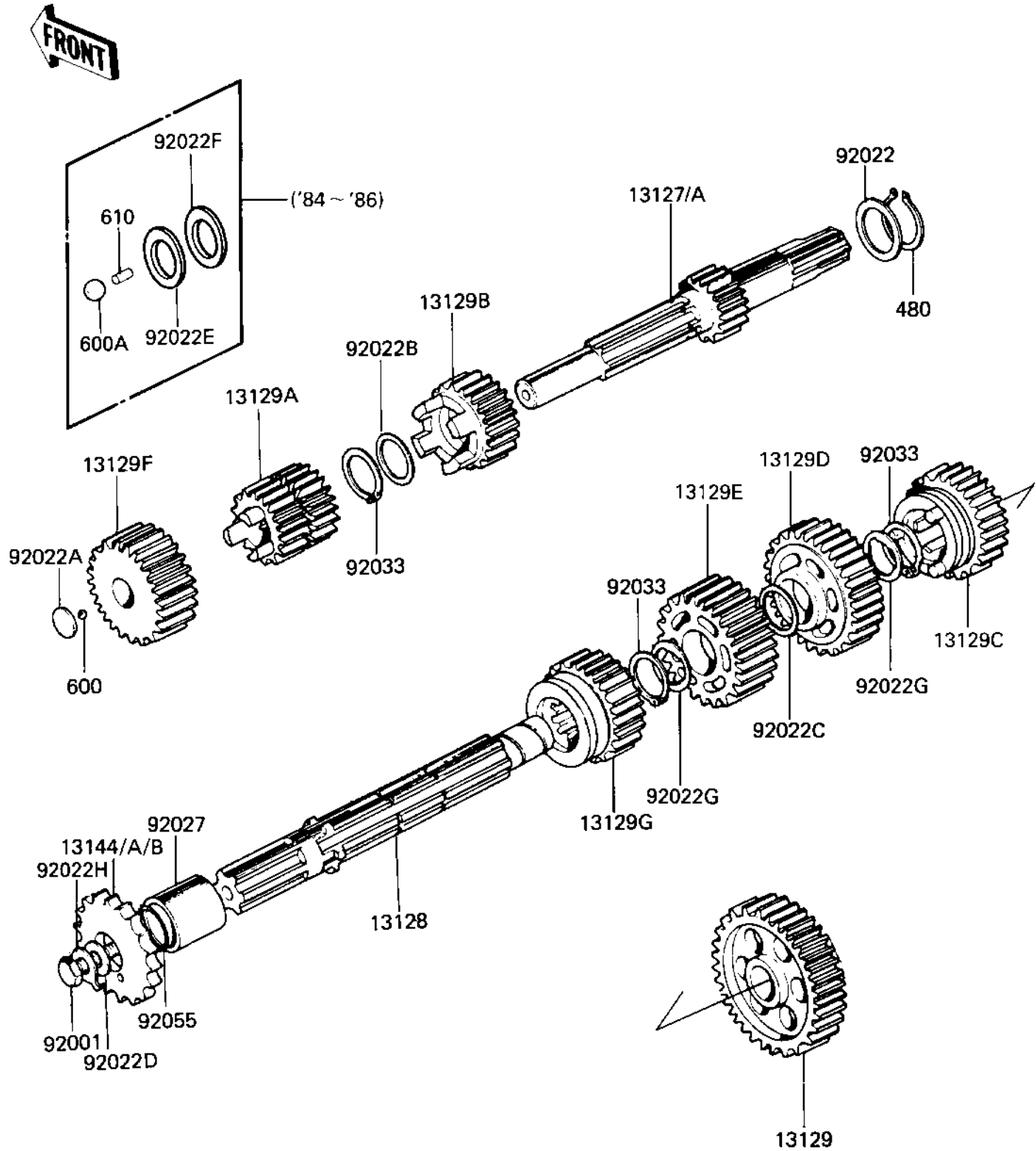

1983 KD80 PARTS LIST

TRANSMISSION

ITEM NAME	PART NUMBER	QUANTITY
SHAFT,DRIVE (Ref # 13127)	13127-1017	1
SHAFT OUTPUT (Ref # 13128)	13128-021	1
LOW GEAR OUTPUT SHAFT (Ref # 13129)	13129-010	1
2ND&3RD GEAR,DRIVE (Ref # 13129A)	13129-1052	1
4TH GEAR,DRIVE (Ref # 13129B)	13129-1053	1
GEAR-TRANSMISSION SPU (Ref # 13129C)	13129-1708	1
2ND GEAR OUTPUT SHAFT (Ref # 13129D)	13131-008	1
3RD GEAR OUTPUT SHAFT (Ref # 13129E)	13133-005	1
GEAR,INPUT TOP,24T (Ref # 13129F)	13129-1927	1
TOP GEAR OUTPUT SHAFT (Ref # 13129G)	13137-012	1
ENGINE SPROCKET,13T (Ref # 13144)	13144-053	1
ENGINE SPROCKET,1ST (Ref # 13144A)	13144-054	1
SPROCKET-OUTPUT,14T (Ref # 13144B)	13144-1058	1
BOLT,UPSET,8X16 (Ref # 92001)	92001-1368	1
WASHER THRUST (Ref # 92022)	92022-053	1
WASHER THRUST (Ref # 92022A)	92022-115	1
WASHER THRUST (Ref # 92022B)	92022-118	1
WASHER THRUST (Ref # 92022C)	92022-146	1
WASHER,ENGINE SPRCKT (Ref # 92022D)	92022-266	1
WASHER-LOCK (Ref # 92022G)	92024-030	2
WASHER,LOCK,8MM (Ref # 92022H)	92030-012	1
COLLAR,ENG SPROCKET (Ref # 92027)	92027-1595	1
CIRCLIP (Ref # 92033)	92033-014	3
"O" RING (Ref # 92055)	92055-022	1
CIRCLIP 16MM (Ref # 480)	480J1600	1
BALL STEEL 7/32' (Ref # 600)	600A0700	1