

1985 LTD Shaft PARTS DIAGRAM

FRONT BEVEL GEARS

E3131-0005

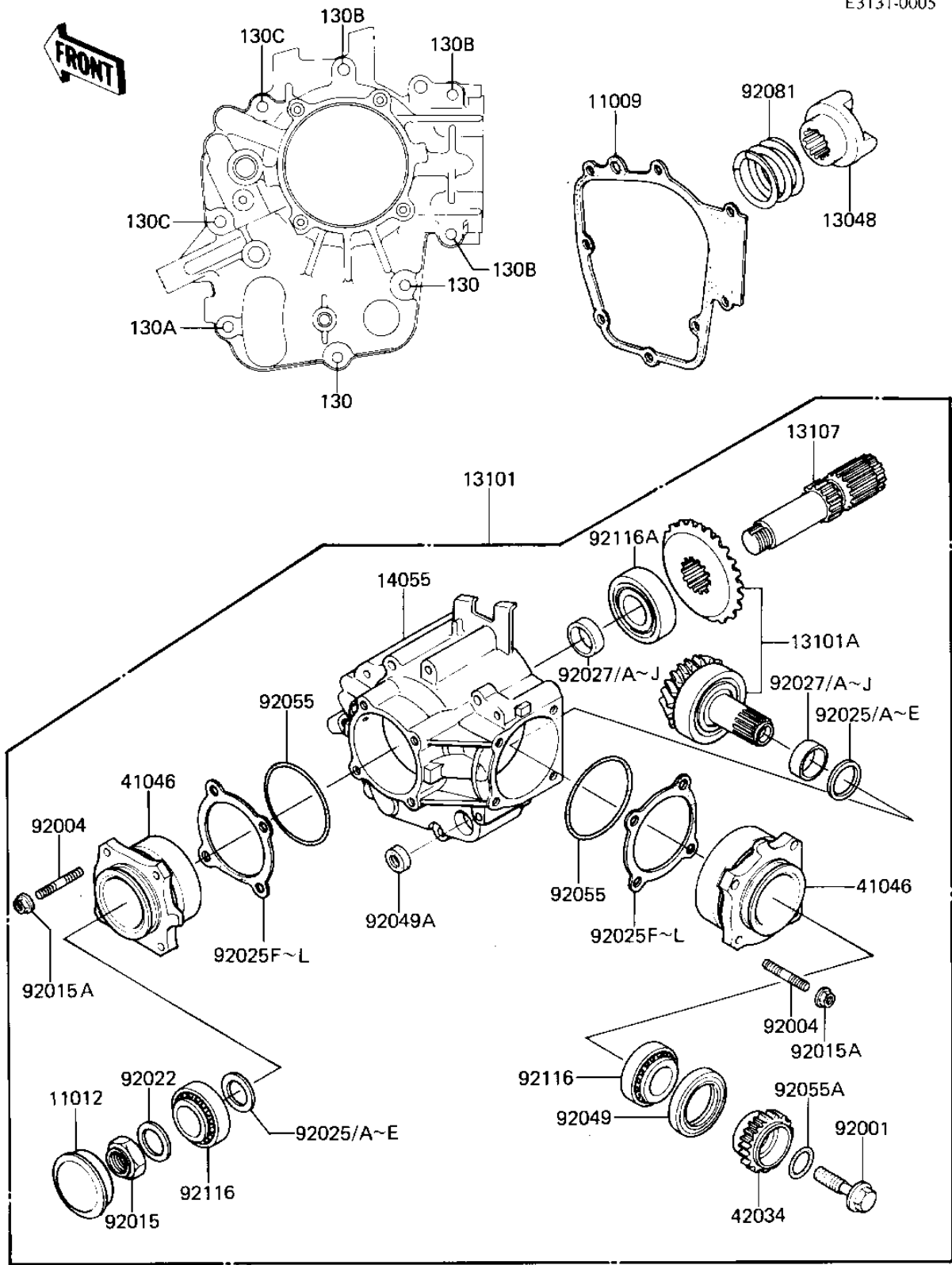

1985 LTD Shaft PARTS LIST

FRONT BEVEL GEARS

ITEM NAME	PART NUMBER	QUANTITY
GASKET,GEAR CASE (Ref # 11009)	11060-1052	1
CAP (Ref # 11012)	11012-1071	1
CAM-DAMPER,BEVEL GEAR (Ref # 13048)	13048-1013	1
GEAR-ASSY,BEVEL,FR (Ref # 13101)	13101-1019	1
GEAR-ASSY,FRONT BEVEL (Ref # 13101A)	13101-5034	1
SHAFT,BEVEL GEAR,FR (Ref # 13107)	13107-1032	1
CASE-GEAR,BEVEL,FR (Ref # 14055)	14055-1006	1
HOUSING-BEARING,FR (Ref # 41046)	41046-1014	2
COUPLING,FR DRIVEN (Ref # 42034)	42034-1091	1
BOLT,12X42 (Ref # 92001)	92001-1169	1
STUD (Ref # 92004)	92004-059	8
NUT,20M/M (Ref # 92015)	92015-1065	1
NUT-6MM (Ref # 92015A)	92015-1078	8
WASHER,PLAIN,2.3X20.3 (Ref # 92022)	92022-1116	1
SHIM,1.70T (Ref # 92025)	92025-1072	AR
SHIM,1.72T (Ref # 92025A)	92025-1073	AR
SHIM,1.74T (Ref # 92025B)	92025-1074	AR
SHIM,1.76T (Ref # 92025C)	92025-1075	AR
SHIM,1.78T (Ref # 92025D)	92025-1076	AR
SHIM,1.80T (Ref # 92025E)	92025-1077	AR
SHIM,T=0.10 (Ref # 92025F)	92025-1258	AR
SHIM,T=0.15 (Ref # 92025G)	92025-1259	AR
SHIM,T=0.20 (Ref # 92025H)	92025-1260	AR
SHIM,T=0.30 (Ref # 92025I)	92025-1261	AR
SHIM,T=0.60 (Ref # 92025J)	92025-1262	AR
SHIM,T=0,90 (Ref # 92025K)	92025-1263	AR
SHIM,T=1.20 (Ref # 92025L)	92025-1264	AR
COLLAR,25.2X29.8X10.2 (Ref # 92027)	92027-1401	AR
COLLAR,25.2X29.8X10.3 (Ref # 92027A)	92027-1402	AR

1985 LTD Shaft PARTS LIST

FRONT BEVEL GEARS

ITEM NAME	PART NUMBER	QUANTITY
COLLAR,25.2X29.8X10.4 (Ref # 92027B)	92027-1403	AR
COLLAR,25.2X29.8X10.5 (Ref # 92027C)	92027-1404	AR
COLLAR,25.2X29.8X10.6 (Ref # 92027D)	92027-1405	AR
COLLAR,25.2X29,8X10.7 (Ref # 92027E)	92027-1406	AR
COLLAR,25X2X29,8X10.8 (Ref # 92027F)	92027-1407	AR
COLLAR,25.2X29.8X10.9 (Ref # 92027G)	92027-1408	AR
COLLAR,25.2X29.8X11.0 (Ref # 92027H)	92027-1409	AR
COLLAR,25.2X29.8X11.1 (Ref # 92027I)	92027-1410	AR
COLLAR,25.2X29.8X11.2 (Ref # 92027J)	92027-1411	AR
OIL SEAL,TC35527 (Ref # 92049)	92049-1038	1
OIL SEAL,TB13225.5 (Ref # 92049A)	92051-005	1
"O" RING,65MM (Ref # 92055)	671B2565	2
"O" RING,I.D=18.64MM (Ref # 92055A)	92055-1044	1
SPRING,CAM DAMPER (Ref # 92081)	92081-1425	1
BEARING (Ref # 92116)	92116-1003	2
BRG,ROLLER,4T-30305 (Ref # 92116A)	92116-1006	1
BOLT,FLANGED,6X25 (Ref # 130)	130G0625	2
BOLT,FLANGED,6X40 (Ref # 130A)	130G0640	1
BOLT-FLANGED,6X75 (Ref # 130B)	130G0675	3
BOLT-FLANGED,6X90 (Ref # 130C)	130G0690	2