

1985 LTD Shaft PARTS DIAGRAM

OIL PUMP/OIL FILTER

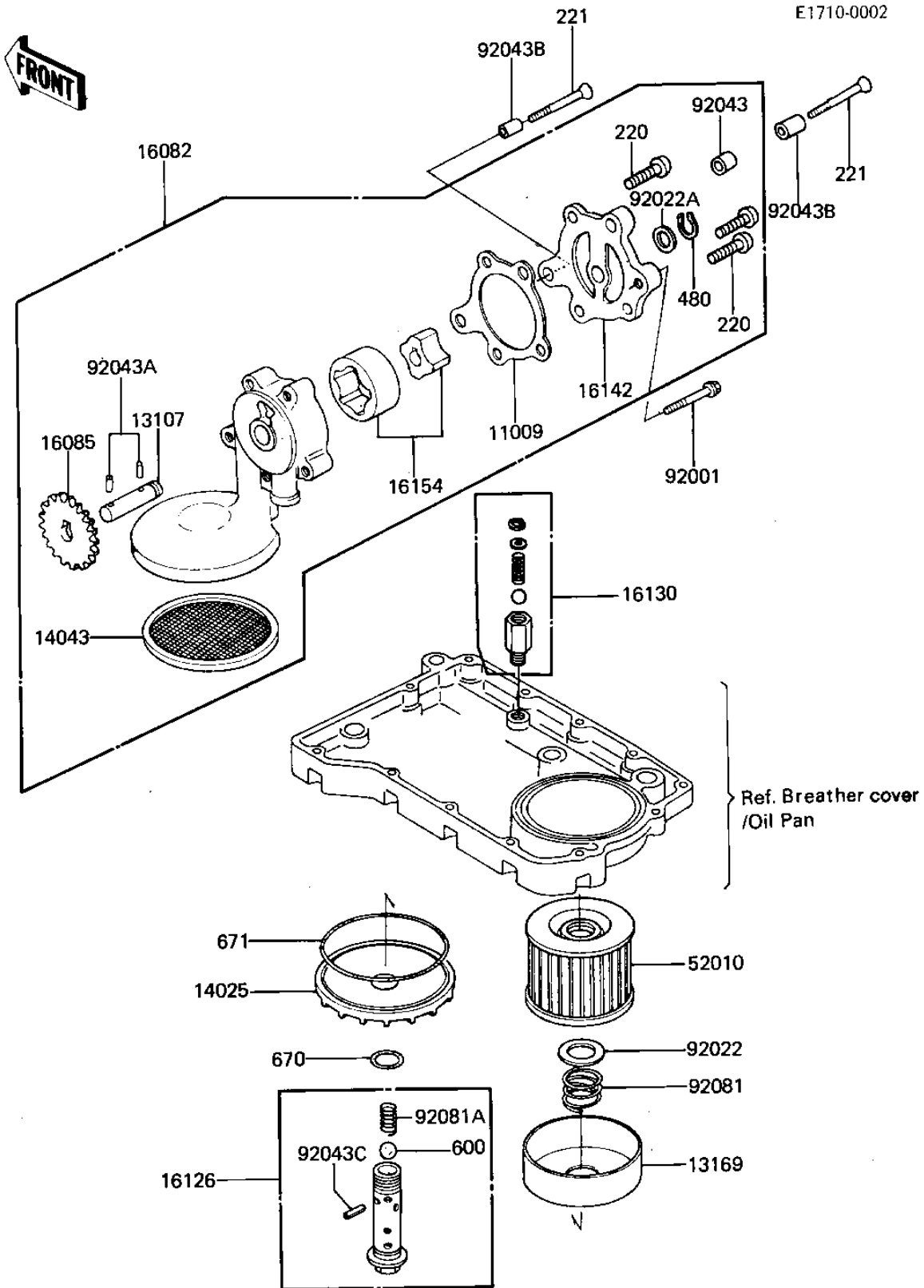

1985 LTD Shaft PARTS LIST

OIL PUMP/OIL FILTER

ITEM NAME	PART NUMBER	QUANTITY
GASKET,OIL PUMP COVER (Ref # 11009)	16145-004	1
SHAFT,OIL PUMP (Ref # 13107)	16086-004	1
PLATE,OIL FILTER (Ref # 13169)	13169-1110	1
COVER,OIL FILTER (Ref # 14025)	16101-004	1
STRAINER,OIL PUMP (Ref # 14043)	16111-004	1
OIL PUMP ASSY (Ref # 16082)	16082-064	1
GEAR,OIL PUMP,57T (Ref # 16085)	16085-025	1
VALVE,OIL FILTER (Ref # 16126)	16126-1108	1
RELEAF VALVE ASSY (Ref # 16130)	16130-1001	1
COVER,OIL PUMP (Ref # 16142)	16142-005	1
ROTOR ASSY,OIL PUMP (Ref # 16154)	16154-003	1
FILTER,OIL (Ref # 52010)	16099-003	1
BOLT,HEX HEAD,6X45 (Ref # 92001)	92001-165	1
WASHER,20.5X30X1.0 (Ref # 92022)	92022-1012	1
WASHER,PLAIN (Ref # 92022A)	92022-311	1
PIN,DOWEL,8X10 (Ref # 92043)	92043-1302	1
PIN,DOWEL (Ref # 92043A)	92042-041	2
PIN,DOWEL,6.2X8X28 (Ref # 92043B)	92042-050	2
SPRING PIN (Ref # 92043C)	92043-111	1
SPRING,OIL FILTER (Ref # 92081)	92081-1018	1
SPRING (Ref # 92081A)	92081-109	1
SCREW PAN HEAD 6X22 (Ref # 220)	220B0622	3
SCREW,CNTSNK HD,6X55 (Ref # 221)	221B0655	2
CIRCLIP,11MM (Ref # 480)	480J1100	1
BALL STEEL 3/8' (Ref # 600)	600A1200	1
"0" RING,16MM (Ref # 670)	670B2016	1
"0" RING,90MM (Ref # 671)	671B2590	1