

1984 KDX200 PARTS DIAGRAM

CYLINDER HEAD/CYLINDER/REED VALVE

E1111-0147

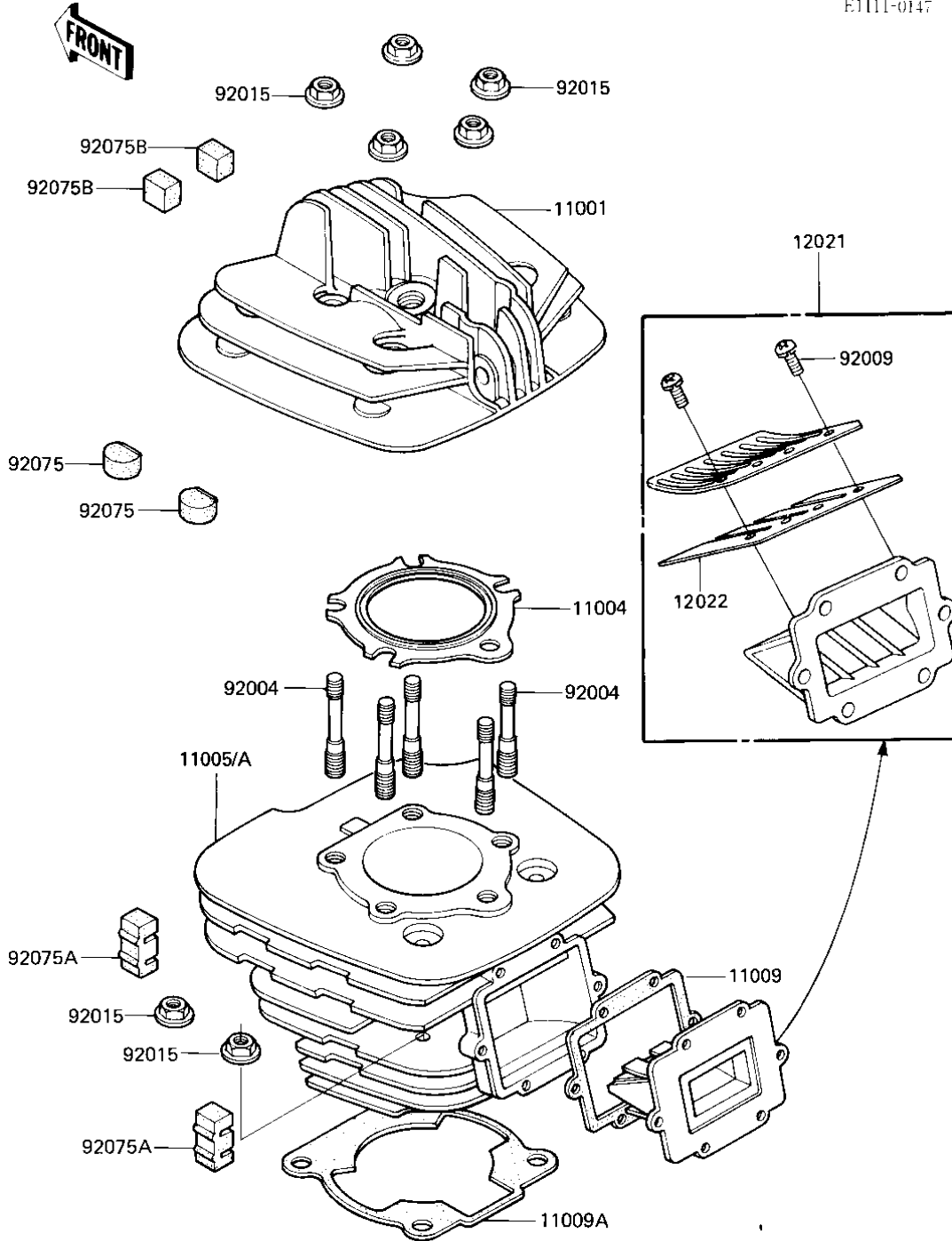

1984 KDX200 PARTS LIST

CYLINDER HEAD/CYLINDER/REED VALVE

ITEM NAME	PART NUMBER	QUANTITY
HEAD-CYLINDER (Ref # 11001)	11001-1119	1
GASKET-HEAD,CYLINDER (Ref # 11004)	11004-1059	1
CYLINDER-ENGINE (Ref # 11005A)	11005-1349	1
GASKET,REED VALVE (Ref # 11009)	11009-1941	1
GASKET,CYLINDER BASE (Ref # 11009A)	11009-1323	1
VALVE-ASSY-REED (Ref # 12021)	12021-1023	1
VALVE-REED (Ref # 12022)	12022-1014	2
STUD,CYLINDER (Ref # 92004)	92004-1026	5
SCREW,REED VALVE (Ref # 92009)	92009-1014	6
NUT-8MM (Ref # 92015)	92015-1143	8
DAMPER RUBBER (Ref # 92075)	92075-1176	8
DAMPER,CYLINDER (Ref # 92075A)	92075-1229	6
DAMPER,CYLINDER HEAD (Ref # 92075B)	92075-1368	9