

1984 LTD Shaft PARTS DIAGRAM

FRONT FORK

F2340-0231

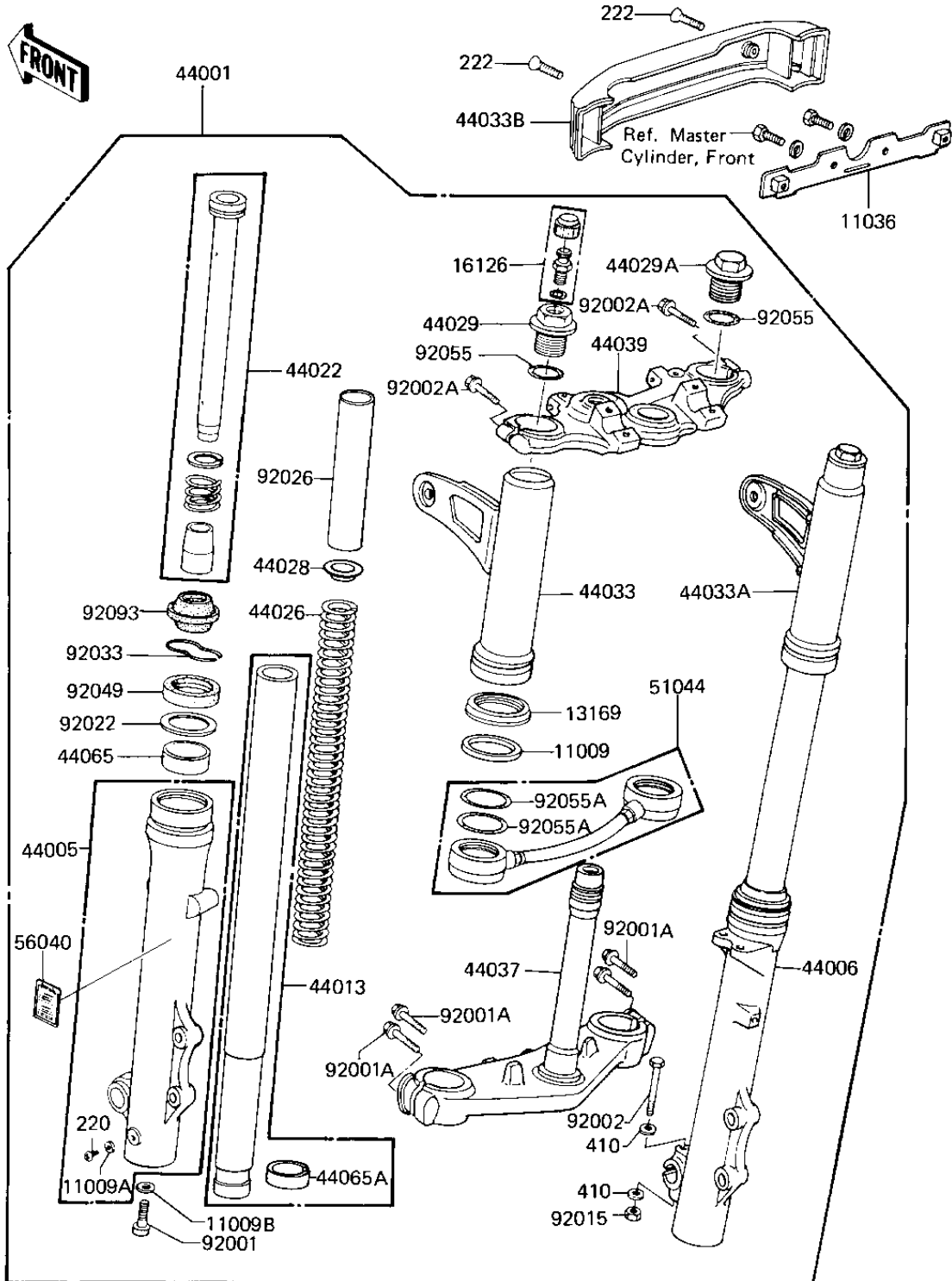

1984 LTD Shaft PARTS LIST

FRONT FORK

ITEM NAME	PART NUMBER	QUANTITY
GASKET,FORK COVER (Ref # 11009)	11009-1015	2
GASKET FORK DRAIN PLG (Ref # 11009A)	44045-002	2
GASKET,FORK CYLINDER (Ref # 11009B)	44045-057	2
BRACKET-A,FORK COVER (Ref # 11036)	11036-1320	1
PLATE,FORK COVER,LWR (Ref # 13169)	13169-1499	2
VALVE AIR (Ref # 16126)	16126-1052	1
FORK-FRONT (Ref # 44001)	44001-1535	1
PIPE-LEFT FORK OUTER (Ref # 44005)	44005-1218	1
PIPE-RIGHT FORK OUTER (Ref # 44006)	44006-1218	1
PIPE-FORK INNER (Ref # 44013)	44013-1220	2
CYLINDER-FORK (Ref # 44022)	44022-1168	2
SPRING-FRONT FORK (Ref # 44026)	44026-1278	2
GUIDE,FORK SPRING (Ref # 44028)	44028-1004	2
SEAT-FORK SPRING,LH (Ref # 44029)	44029-1044	2
SEAT-FORK SPRING,RH (Ref # 44029A)	44029-1045	1
COVER-FORK,LH (Ref # 44033)	44033-1153	1
COVER-FORK,RH (Ref # 44033A)	44033-1154	1
COVER-FORK,KAWASAKI (Ref # 44033B)	44033-1157	1
HOLDER-FORK UNDER (Ref # 44037)	44037-1109	1
HOLDER-FORK UPPER (Ref # 44039)	44039-1105	1
BUSHING-FRONT FORK,OU (Ref # 44065)	44065-1091	2
BUSHING,FORK PIPE (Ref # 44065A)	92028-1126	2
TUBE-ASSY (Ref # 51044)	51044-1060	1
LABEL-WARNING,FRONT F (Ref # 56040)	56040-1110	1
BOLT-FORK CYLINDER (Ref # 92001)	44041-040	2
BOLT,8X40 (Ref # 92001A)	92001-1188	4
BOLT,8X55 (Ref # 92002)	92002-1160	1
BOLT,FLANGED,8X45 (Ref # 92002A)	92002-1288	2
NUT,LOCK,8MM (Ref # 92015)	92015-1390	1

1984 LTD Shaft PARTS LIST

FRONT FORK

ITEM NAME	PART NUMBER	QUANTITY
WASHER,FORK OUT PIPE (Ref # 92022)	92022-1262	2
SPACER (Ref # 92026)	92026-1234	2
SNAP RING,FORK OUTER (Ref # 92033)	92033-1047	2
SEAL-OIL,FORK (Ref # 92049)	92049-1178	2
"0" RING,FORK TOP (Ref # 92055)	92055-1051	2
RING-O,ROD (Ref # 92055A)	92055-1369	4
SEAL,FORK (Ref # 92093)	92093-1162	2
SCREW PAN HEAD 4X8 (Ref # 220)	220E0408	2
SCREW-CSK-RD-CROS (Ref # 222)	222C0518	2
WASHER PLAIN 8MM (Ref # 410)	410D0800	2