

1984 LTD Shaft PARTS DIAGRAM

GENERATOR/REGULATOR

E1810-0111

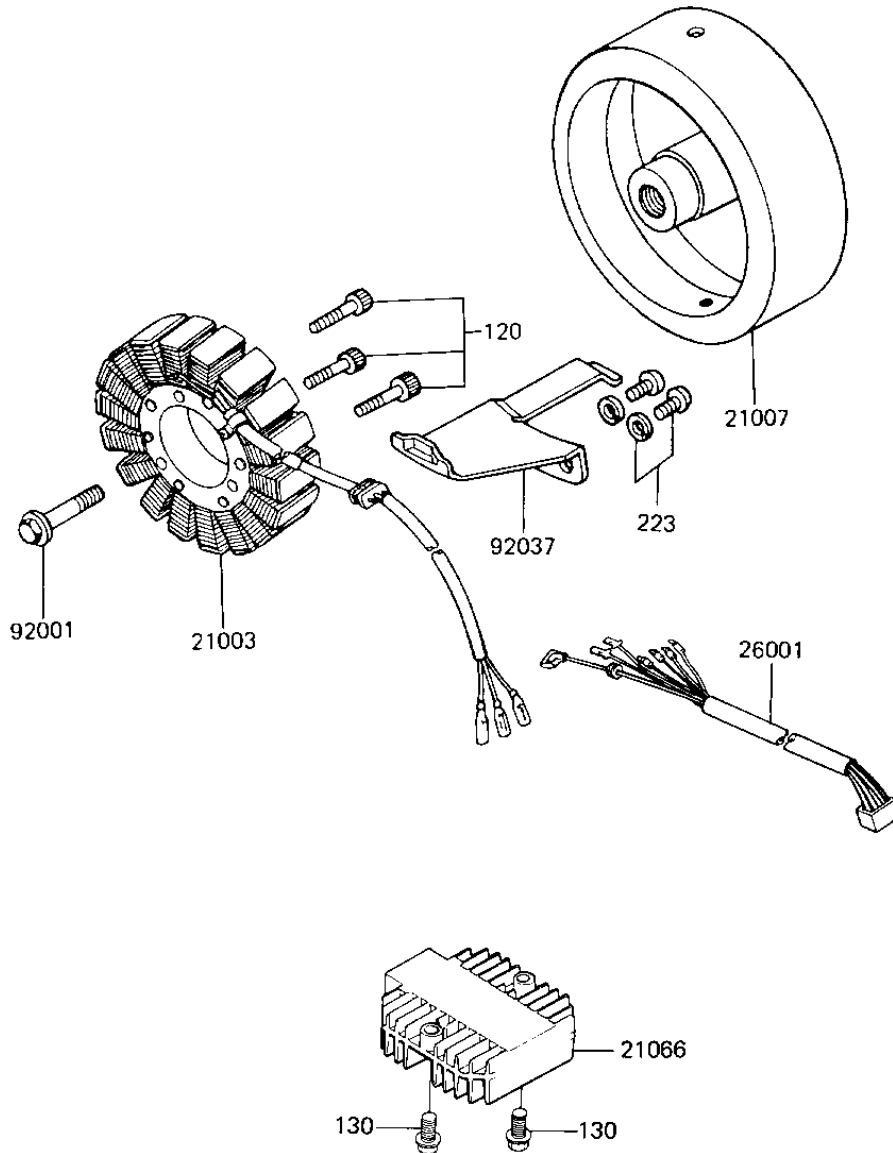

1984 LTD Shaft PARTS LIST

GENERATOR/REGULATOR

ITEM NAME	PART NUMBER	QUANTITY
STATOR (Ref # 21003)	21003-1040	1
ROTOR,GENERATOR (Ref # 21007)	21007-1076	1
REGULATOR-VOLTAGE (Ref # 21006)	21066-1055	1
HARNESS (Ref # 26001)	26001-1652	1
BOLT,12X40 (Ref # 92001)	92001-1146	1
CLAMP (Ref # 92037)	92037-1214	1
BOLT,SOCKET,6X30 (Ref # 120)	120P0630	3
BOLT,FLANGED,6X20 (Ref # 130)	130B0620	2
SCREW-PAN-WS-CROS (Ref # 223)	223B0512	2