

1984 LTD Shaft PARTS DIAGRAM

ENGINE COVERS

E1431-0151

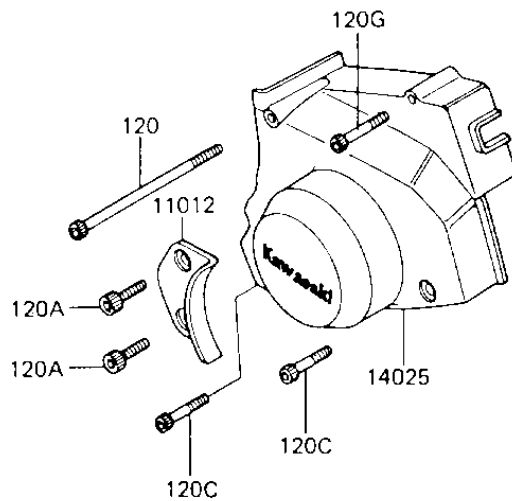
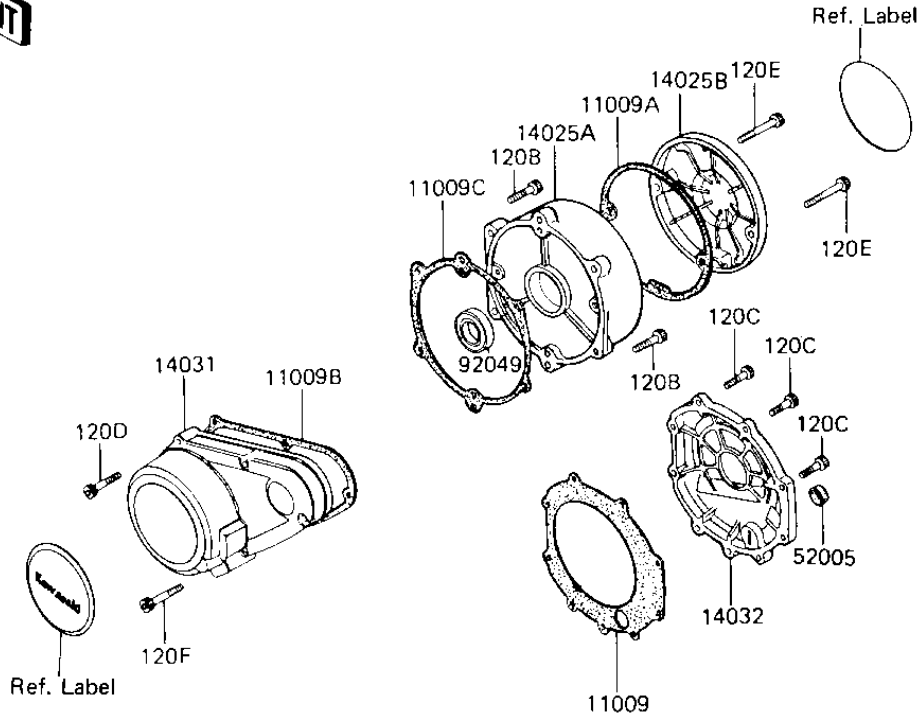

1984 LTD Shaft PARTS LIST

ENGINE COVERS

ITEM NAME	PART NUMBER	QUANTITY
GASKET,CLUTCH COVER (Ref # 11009)	11060-1070	1
GASKET,PULSING COIL C (Ref # 11009A)	11060-1072	1
GASKET,GENERATOR COVE (Ref # 11009B)	11060-1075	1
GASKET,RH ENGINE COVE (Ref # 11009C)	11060-1071	1
CAP,CLUTCH RELEASE AJ (Ref # 11012)	11012-1064	1
COVER,FRONT BEVEL GEA (Ref # 14025)	14025-1827	1
COVER,ENGINE,RH (Ref # 14025A)	14025-1828	1
COVER,PULSING COIL (Ref # 14025B)	14025-1829	1
COVER-GENERATOR (Ref # 14031)	14031-1162	1
COVER-CLUTCH (Ref # 14032)	14032-1162	1
GAUGE,OIL LEVEL (Ref # 52005)	52005-1009	1
OIL SEAL,SC32487 (Ref # 92049)	92049-1033	1
BOLT-SOCKET (Ref # 120)	120Z06125	1
BOLT-SOCKET (Ref # 120A)	120Z0614	2
BOLT-SOCKET (Ref # 120B)	120Z0622	6
BOLT-SOCKET (Ref # 120C)	120Z0625	11
BOLT-SOCKET (Ref # 120D)	120Z0630	6
BOLT-SOCKET (Ref # 120E)	120Z0635	2
BOLT-SOCKET (Ref # 120F)	120Z0640	1
BOLT-SOCKET (Ref # 120G)	120Z0645	1