

1986 Eliminator PARTS DIAGRAM

GENERATOR/REGULATOR

E1810-0114

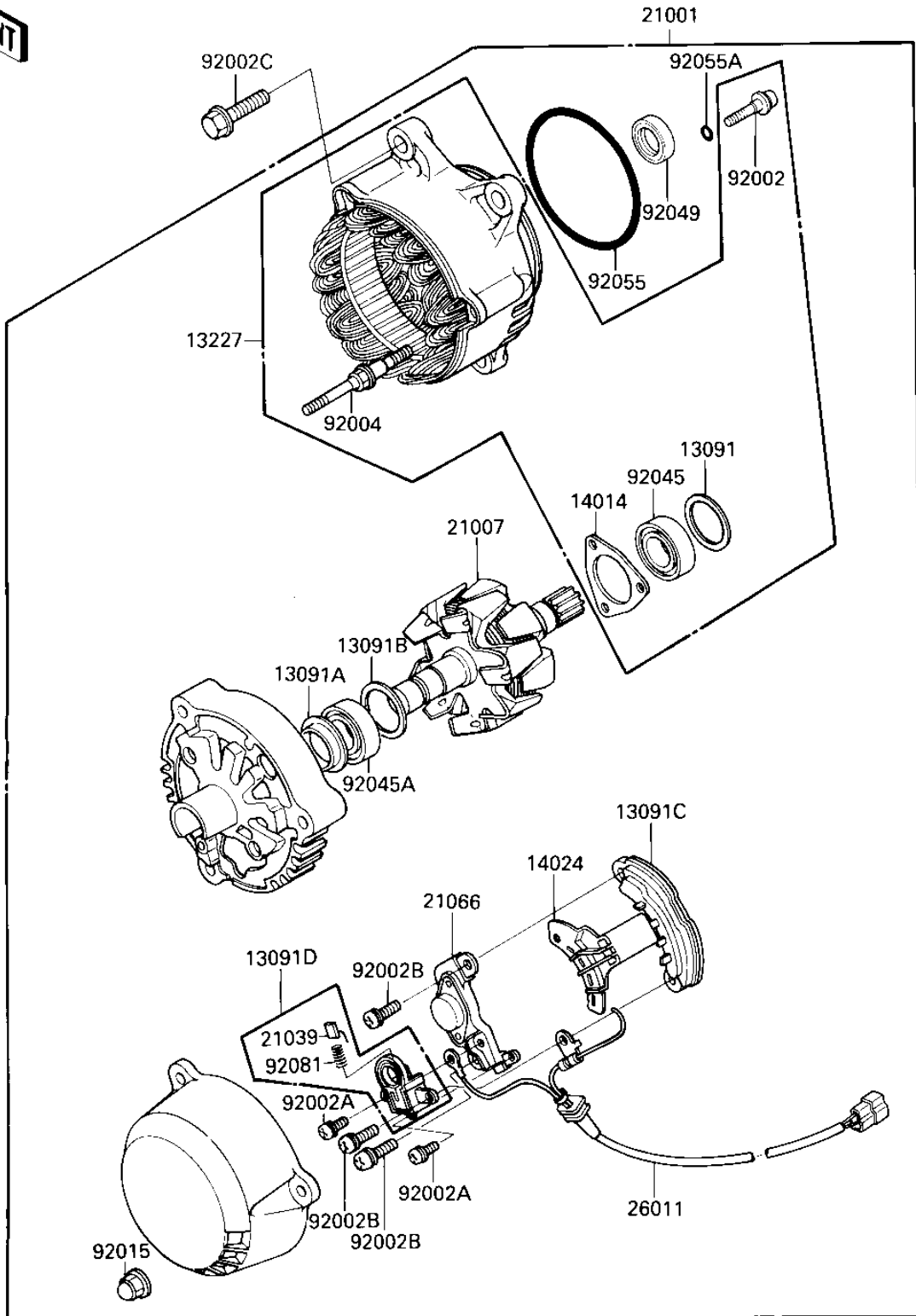

1986 Eliminator PARTS LIST

GENERATOR/REGULATOR

ITEM NAME	PART NUMBER	QUANTITY
HOLDER,BEARING (Ref # 13091)	13091-1326	1
HOLDER,COVER (Ref # 13091A)	13091-1327	1
HOLDER,BEARING (Ref # 13091B)	13091-1328	1
RECTIFIER (Ref # 13091C)	13091-1329	1
HOLDER,BRUSH (Ref # 13091D)	13091-1330	1
HOUSING,GENERATOR (Ref # 13227)	13227-1054	1
PLATE-POSITION (Ref # 14014)	14014-1065	1
COVER,RECTIFIER (Ref # 14024)	14025-1942	1
GENERATOR (Ref # 21001)	21001-1106	1
ROTOR,GENERATOR (Ref # 21007)	21007-1123	1
BRUSH,CARBON (Ref # 21039)	21039-1052	2
REGULATOR-VOLTAGE (Ref # 21066)	21066-1056	1
WIRE-LEAD,GENERATOR (Ref # 26011)	26011-1317	1
BOLT (Ref # 92002)	92002-1856	3
BOLT (Ref # 92002A)	92002-1379	2
BOLT (Ref # 92002B)	92002-1380	3
BOLT,8X32 (Ref # 92002C)	92002-1400	3
STUD (Ref # 92004)	92004-1196	3
NUT,CAP (Ref # 92015)	92015-1458	3
BEARING-BALL,#6002 (Ref # 92045)	92045-1132	1
BEARING-BALL (Ref # 92045A)	92045-1237	1
SEAL-OIL (Ref # 92049)	92049-1200	1
RING-O,67.6MM (Ref # 92055)	92055-1263	1
RING-O (Ref # 92055A)	92055-1264	3
SPRING,BRUSH (Ref # 92081)	92081-1759	2