

1986 Bayou 300 PARTS DIAGRAM

CLUTCH

E1350-0123

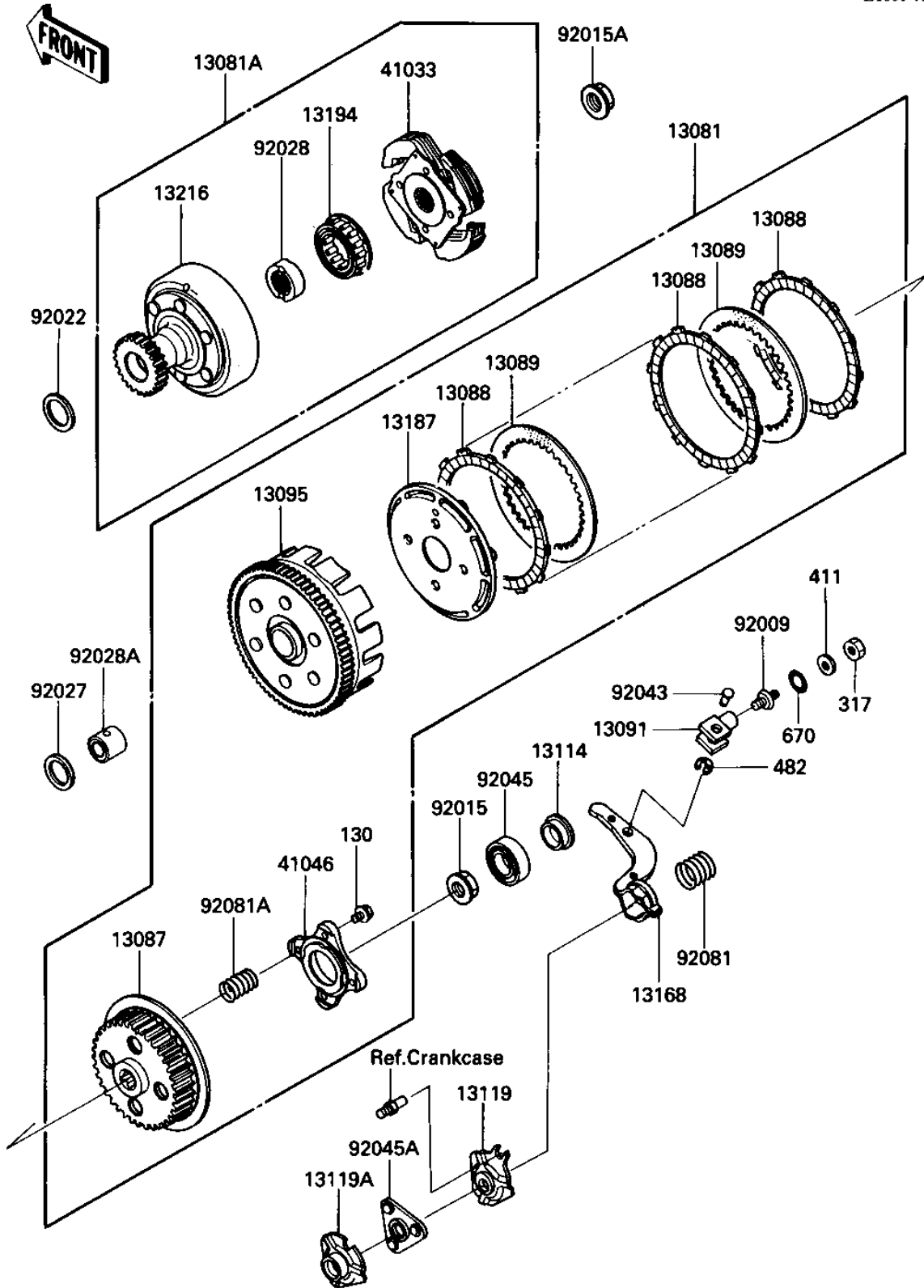

1986 Bayou 300 PARTS LIST

CLUTCH

ITEM NAME	PART NUMBER	QUANTITY
CLUTCH-ASSY (Ref # 13081)	13081-1203	1
CLUTCH-ASSY,FR (Ref # 13081A)	13081-1204	1
HUB-CLUTCH (Ref # 13087)	13087-1065	1
PLATE,CLUTCH FRICTION (Ref # 13088)	13088-041	1
PLATE,CLUTCH,STEEL (Ref # 13089)	13089-1005	1
HOLDER,CLUTCH RELEASE (Ref # 13091)	13091-1341	1
HOUSING-COMP-CLUTCH (Ref # 13095)	13095-1133	1
PUSHER-CLUTCH (Ref # 13114)	13114-1056	1
CAM-RELEASE (Ref # 13119)	13119-1060	1
CAM-RELEASE (Ref # 13119A)	13119-1054	1
LEVER,CLUTCH RELEASE (Ref # 13168)	13168-1263	1
PLATE-CLUTCH OPERATIN (Ref # 13187)	13187-1053	1
CLUTCH-ONEWAY (Ref # 13194)	13194-1055	1
GEAR-COMP,CLUTCH,FR (Ref # 13216)	13216-1073	1
HUB-ASSY,CLUTCH,FR (Ref # 41033)	41033-1937	1
HOUSING-BEARING (Ref # 41046)	41046-1063	1
SCREW,CLUTCH RELEASE (Ref # 92009)	92009-1303	1
NUT (Ref # 92015)	92015-1465	1
NUT,18MM (Ref # 92015A)	92015-1512	1
WASHER,27.3X38X1.5 (Ref # 92022)	92022-1683	1
COLLAR,20.5X34X4 (Ref # 92027)	92027-1888	1
BUSHING (Ref # 92028)	92028-1370	1
BUSHING,CLUTCH (Ref # 92028A)	92028-1371	1
PIN,CLUTCH RELEASE (Ref # 92043)	92043-1230	1
BEARING,BALL,#6905 (Ref # 92045)	92045-036	1
RETAINER,CLUTCH RELEA (Ref # 92045A)	14020-1093	1
SPRING,SHOCKABSORBER, (Ref # 92081)	92081-1681	1
SPRING,CLUTCH (Ref # 92081A)	92081-1848	1
BOLT-FLANGED,6X20 (Ref # 130)	130P0620	1

1986 Bayou 300 PARTS LIST

CLUTCH

ITEM NAME	PART NUMBER	QUANTITY
NUT,8M/M (Ref # 317)	317B0800	1
WASHER PLAIN 8MM (Ref # 411)	411B0800	1
CIRCLIP 6MM (Ref # 482)	482J6000	1
"O" RING,8MM (Ref # 670)	670B1508	1