

1985 KL600 PARTS DIAGRAM

REAR HUB/BRAKE/CHAIN

F2240-0172

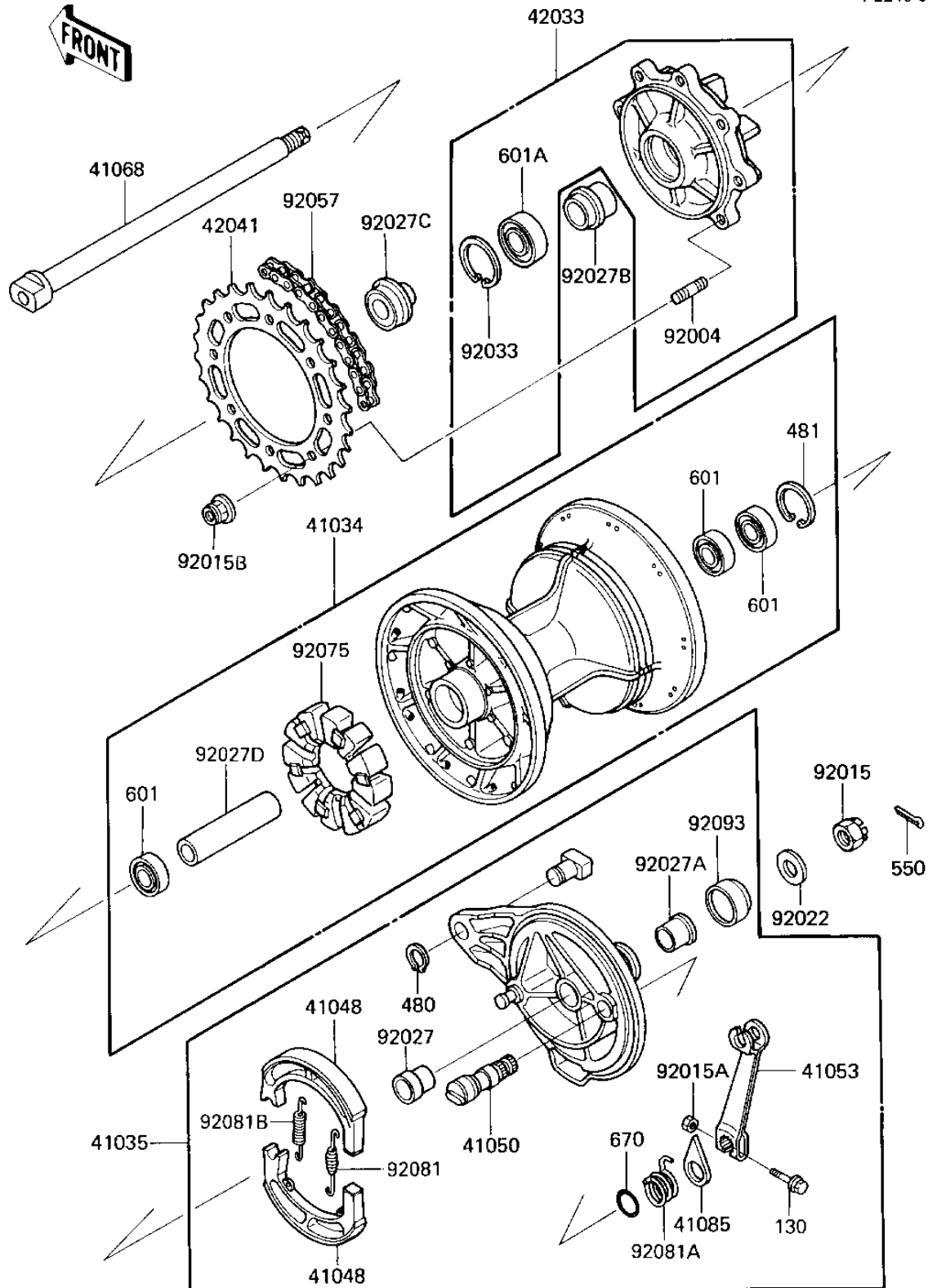

1985 KL600 PARTS LIST

REAR HUB/BRAKE/CHAIN

ITEM NAME	PART NUMBER	QUANTITY
DRUM-ASSY,REAR BRAKE (Ref # 41034)	41034-1107	1
PANEL-ASSY-BRAKE,RR (Ref # 41035)	41035-1194	1
SHOE-BRAKE (Ref # 41048)	41048-1060	1
CAM-BRAKE (Ref # 41050)	41050-1060	1
LEVER-BRAKE CAM (Ref # 41053)	41053-1051	1
AXLE,RR (Ref # 41068)	41068-1184	1
INDICATOR,FR BRK PNL (Ref # 41085)	41085-005	1
COUPLING-ASSY,REAR HU (Ref # 42033)	42033-1112	1
SPROCKET-HUB,43T (Ref # 42041)	42041-1185	1
STUD (Ref # 92004)	92004-1150	1
NUT CASTLE 16M/M (Ref # 92015)	42045-014	1
NUT-6MM (Ref # 92015A)	92015-1078	1
NUT (Ref # 92015B)	92015-1506	1
WASHER SLEEVE (Ref # 92022)	42046-009	1
COLLAR,REAR BRAKE PAN (Ref # 92027)	92027-1689	1
COLLAR,REAR BRAKE PAN (Ref # 92027A)	92027-1690	1
COLLAR,REAR HUB COUPL (Ref # 92027B)	92027-1770	1
COLLAR,REAR HUB COUPL (Ref # 92027C)	92027-1771	1
COLLAR,REAR BRAKE DRU (Ref # 92027D)	92027-1772	1
CIRCLIP,42MM (Ref # 92033)	92033-1041	1
CHAIN,DRIVE,EK520LDOX (Ref # 92057)	92057-1177	1
DAMPER,RR HUB,SHOCK (Ref # 92075)	92075-1068	1
SPRING,BRAKE SHOE (Ref # 92081)	92081-1550	1
SPRING,BRAKE CAM LEVE (Ref # 92081A)	92081-1615	1
SPRING,BRAKE SHOE (Ref # 92081B)	92081-1766	1
OIL SEAL (Ref # 92093)	92093-1004	1
BOLT,FLANGED,6X30 (Ref # 130)	130G0630	1
CIRCLIP 14MM (Ref # 480)	480J1400	1
CIRCLIP,35MM (Ref # 481)	481J3500	1

1985 KL600 PARTS LIST

REAR HUB/BRAKE/CHAIN

ITEM NAME	PART NUMBER	QUANTITY
PIN-COTTER,4.0X35 (Ref # 550)	550D4035	1
BEARING-BALL,#6003UC3 (Ref # 601)	601B6003U	1
BEARING-BALL,#6004U (Ref # 601A)	601B6004U	1
"O" RING,15MM (Ref # 670)	670B2015	1