

1982 AR50-A1 PARTS DIAGRAM

HEADLIGHT

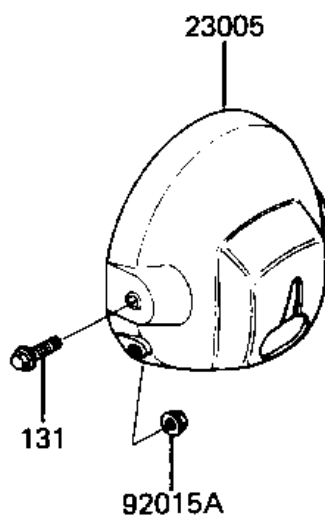

F2710-0123

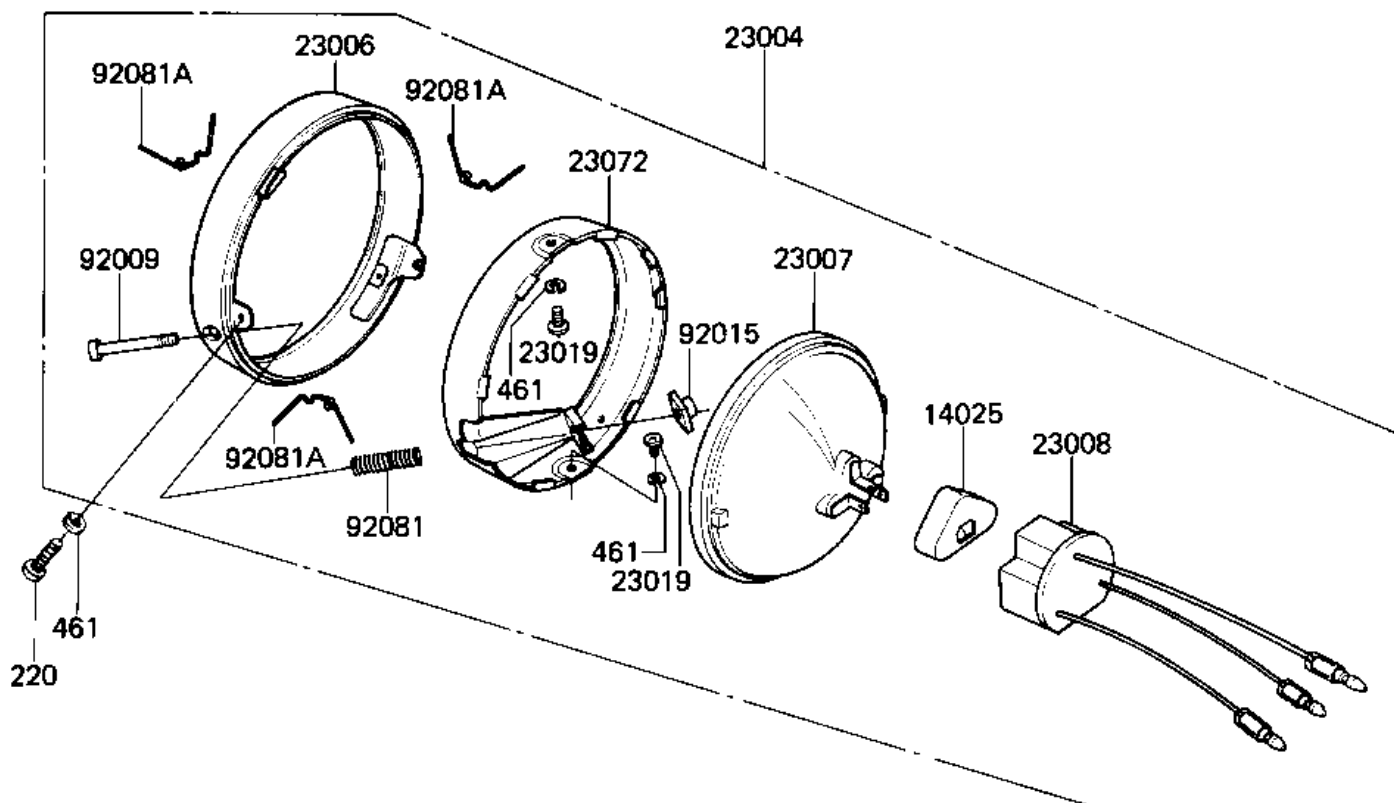

1982 AR50-A1 PARTS LIST

HEADLIGHT

ITEM NAME	PART NUMBER	QUANTITY
COVER,HD LAMP SOCKET (Ref # 14025)	23081-001	1
LAMP-HEAD (Ref # 23004)	23004-1078	1
BODY-COMP-HEAD LAMP,B (Ref # 23005)	23005-1017-6Z	1
RIM-LAMP,HEAD (Ref # 23006)	23006-1018	1
SEALED BEAM UNIT (Ref # 23007)	23007-055	1
SOCKET-ASSY (Ref # 23008)	23008-1125	1
SCREW,LENS FITTING (Ref # 23019)	23019-031	1
RETAINER,HEAD LAMP (Ref # 23072)	23072-005	1
SCREW,FOCUS ADJUST (Ref # 92009)	23019-027	1
NUT ADJUST (Ref # 92015)	23020-012	1
NUT,8M/M (Ref # 92015A)	92015-1014	1
SPRING,FOCUS ADJUST (Ref # 92081)	23014-012	1
SPRING,HEAD LAMP LENS (Ref # 92081A)	92081-1144	1
BOLT-FLANGED,8X20 (Ref # 131)	131B0820	1
SCREW PAN HEAD 5X12 (Ref # 220)	220B0512	1
WASHER SPRING 5MM (Ref # 461)	461F0500	1