

## 1983 KE125 PARTS DIAGRAM

FRAME FITTINGS ('82-'83 A9/A10)

F2130-0012

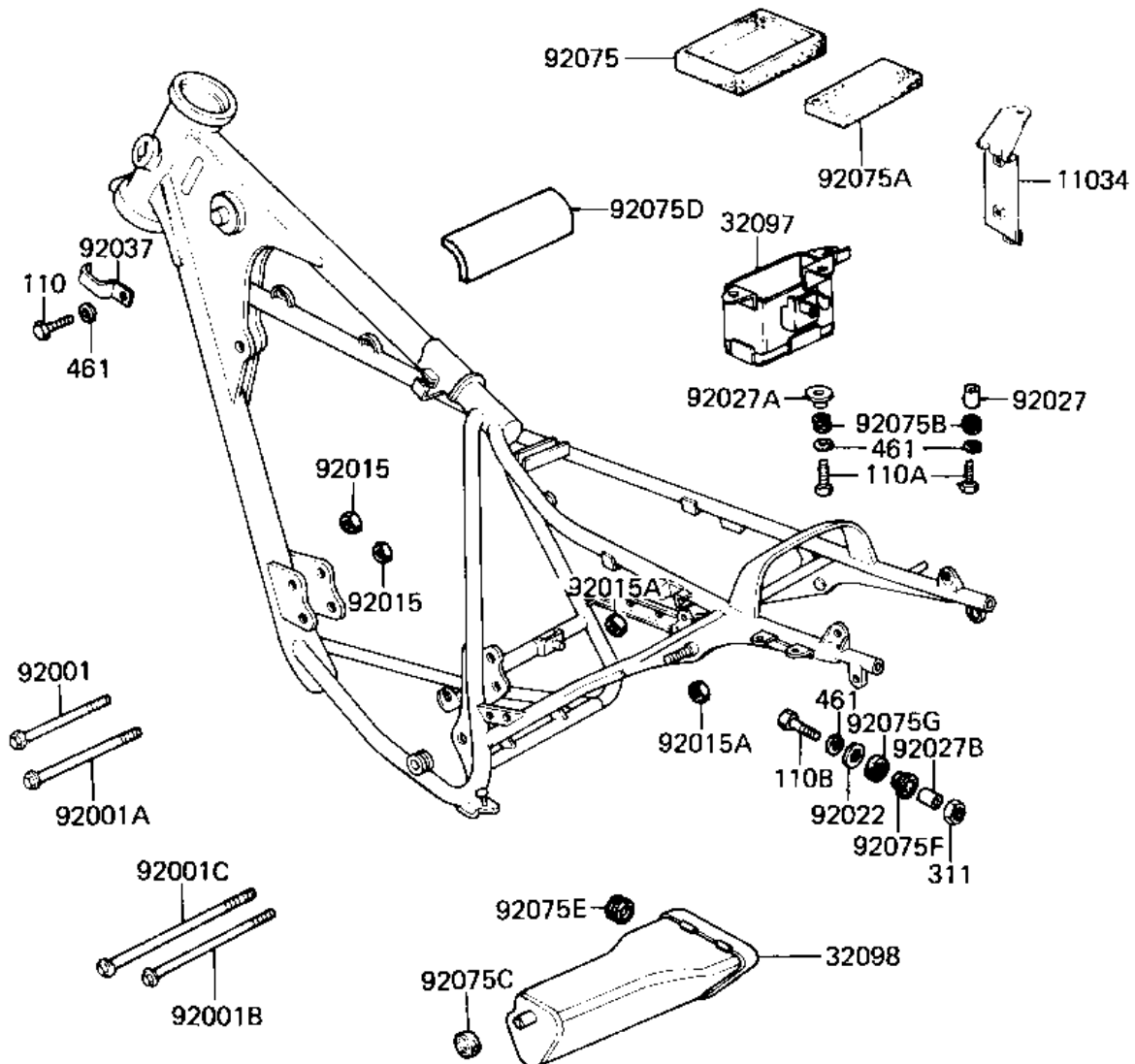

## 1983 KE125 PARTS LIST

FRAME FITTINGS ('82-'83 A9/A10)

ITEM NAME	PART NUMBER	QUANTITY
BRACKET,REGULATOR (Ref # 11034)	11034-1798	1
CASE-BATTERY (Ref # 32097)	32097-030	1
CASE,TOOL (Ref # 32098)	32098-022	1
BOLT-FLANGE (Ref # 92001)	92001-1582	1
BOLT FLANGED,8X70 (Ref # 92001A)	92001-1583	1
BOLT,FLANGED,10X115 (Ref # 92001B)	92001-1603	1
BOLT,FLANGED,10X130 (Ref # 92001C)	92001-1604	1
NUT,LOCK,8MM (Ref # 92015)	92015-1124	1
NUT,10MM (Ref # 92015A)	92015-1429	1
WASHER,PLAIN,7MM (Ref # 92022)	92022-228	1
COLLAR (Ref # 92027)	92027-103	1
COLLAR (Ref # 92027A)	92027-153	1
COLLAR,REAR FENDER (Ref # 92027B)	92027-162	1
CLAMP,WIRE HARNESS (Ref # 92037)	92037-150	1
MAT-BATTERY SIDE (Ref # 92075)	32103-023	1
MAT,BATTERY (Ref # 92075A)	32103-027	1
DAMPER RUBBER (Ref # 92075B)	92075-051	1
DAMPER RUBBER (Ref # 92075C)	92075-107	1
DAMPER,AIR CLEANER (Ref # 92075D)	92075-1085	1
DAMPER RUBBER-OIL TNK (Ref # 92075E)	92075-150	1
RUBBER,FENDER COVER (Ref # 92075F)	92075-174	1
DAMPER RUBBER (Ref # 92075G)	92075-175	1
BOLT-UPSET 6X14 (Ref # 110)	112B0614	1
BOLT-UPSET,6X16 (Ref # 110A)	112G0616	1
BOLT-UPSET (Ref # 110B)	112G0625	1
NUT 6MM (Ref # 311)	311B0600	1
WASHER SPRING 6MM (Ref # 461)	461F0600	1