

## 1983 KE125 PARTS DIAGRAM

GENERATOR/REGULATOR ('82-'83 A9/A10)

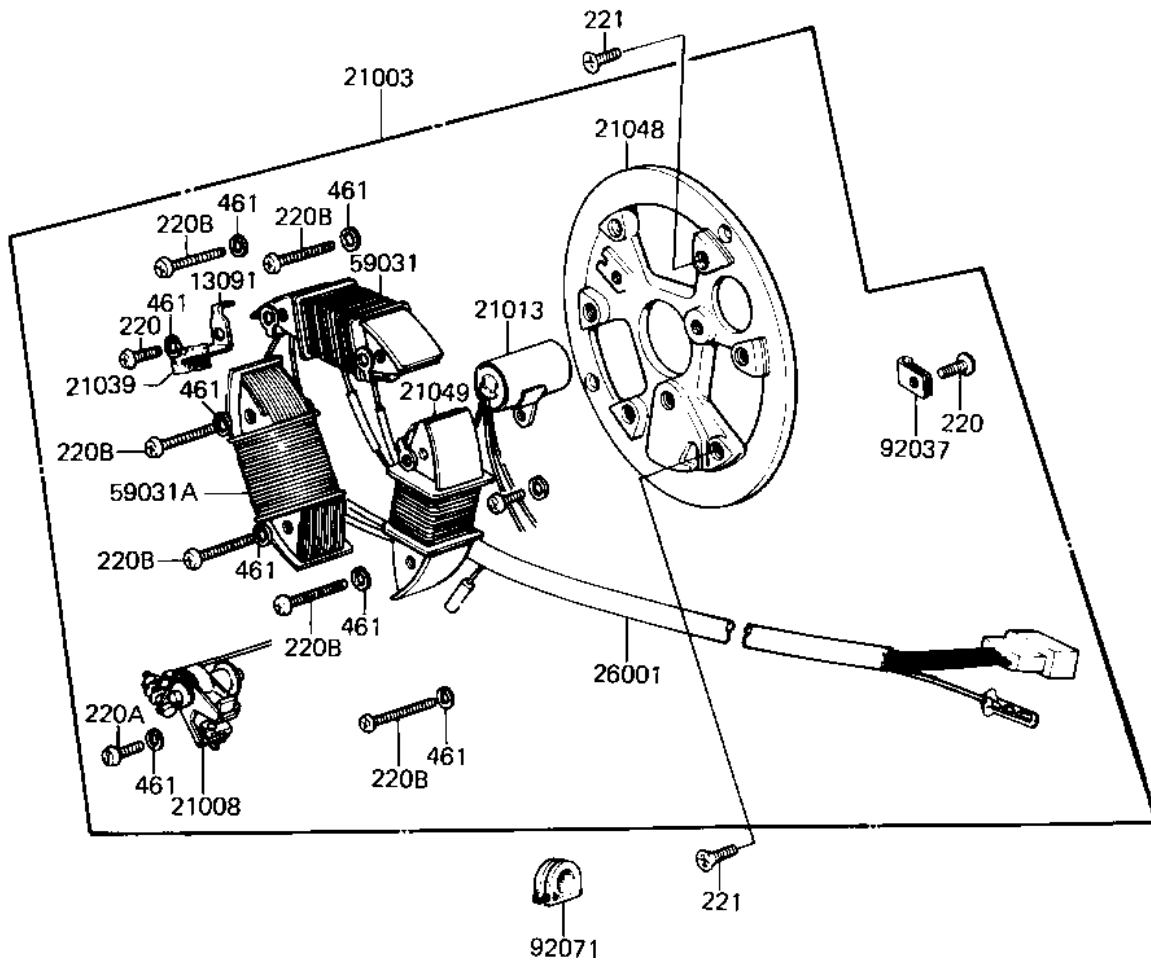
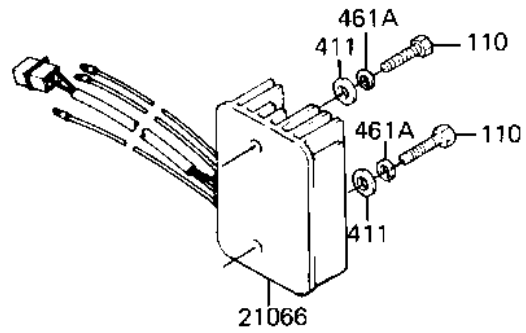
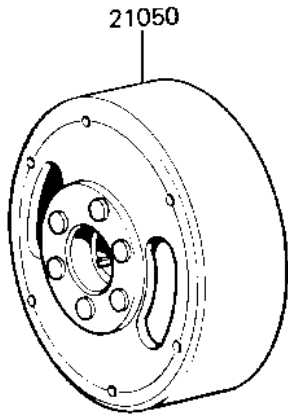

## 1983 KE125 PARTS LIST

GENERATOR/REGULATOR ('82-'83 A9/A10)

ITEM NAME	PART NUMBER	QUANTITY
HOLDER,OIL FELT (Ref # 13091)	21038-002	1
STATOR ASSY (Ref # 21003)	21003-1014	1
BREAKER ASSY CONTACT (Ref # 21008)	21008-006	1
CONDENSER (Ref # 21013)	21013-006	1
FELT OIL (Ref # 21039)	21019-005	1
PLATE-COIL,MAGNETO (Ref # 21048)	21048-1002	1
COIL,EXCITING (Ref # 21049)	21049-1004	1
FLYWHEEL,MAGNETO (Ref # 21050)	21050-1008	1
REGULATOR,VOLTAGE (Ref # 21066)	21066-1012	1
WIRING HARNESS,MAGNET (Ref # 26001)	26001-1077	1
COIL,CHARGING A (Ref # 59031)	59031-1001	1
COIL,CHARGING B (Ref # 59031A)	59031-1002	1
CLAMP WIRING HARNESS (Ref # 92037)	21037-002	1
GROMMET WIRING HARN (Ref # 92071)	21017-002	1
BOLT-UPSET (Ref # 110)	112G0625	1
SCREW PAN HEAD 4X6 (Ref # 220)	220B0406	1
SCREW-PAN-CRSOSS,4X12 (Ref # 220A)	220B0412	1
SCREW-PAN-CROS (Ref # 220B)	220B0430	1
SCREW CNTSNK HD 6X14 (Ref # 221)	221B0614	1
WASHER PLAIN 6MM (Ref # 41)	411B0600	1
WASHER SPRING 4MM (Ref # 461)	461F0400	1
WASHER SPRING 6MM (Ref # 461A)	461F0600	1