

1983 KE125 PARTS DIAGRAM

CLUTCH ('82-'83 A9/A10)

E135U-0018

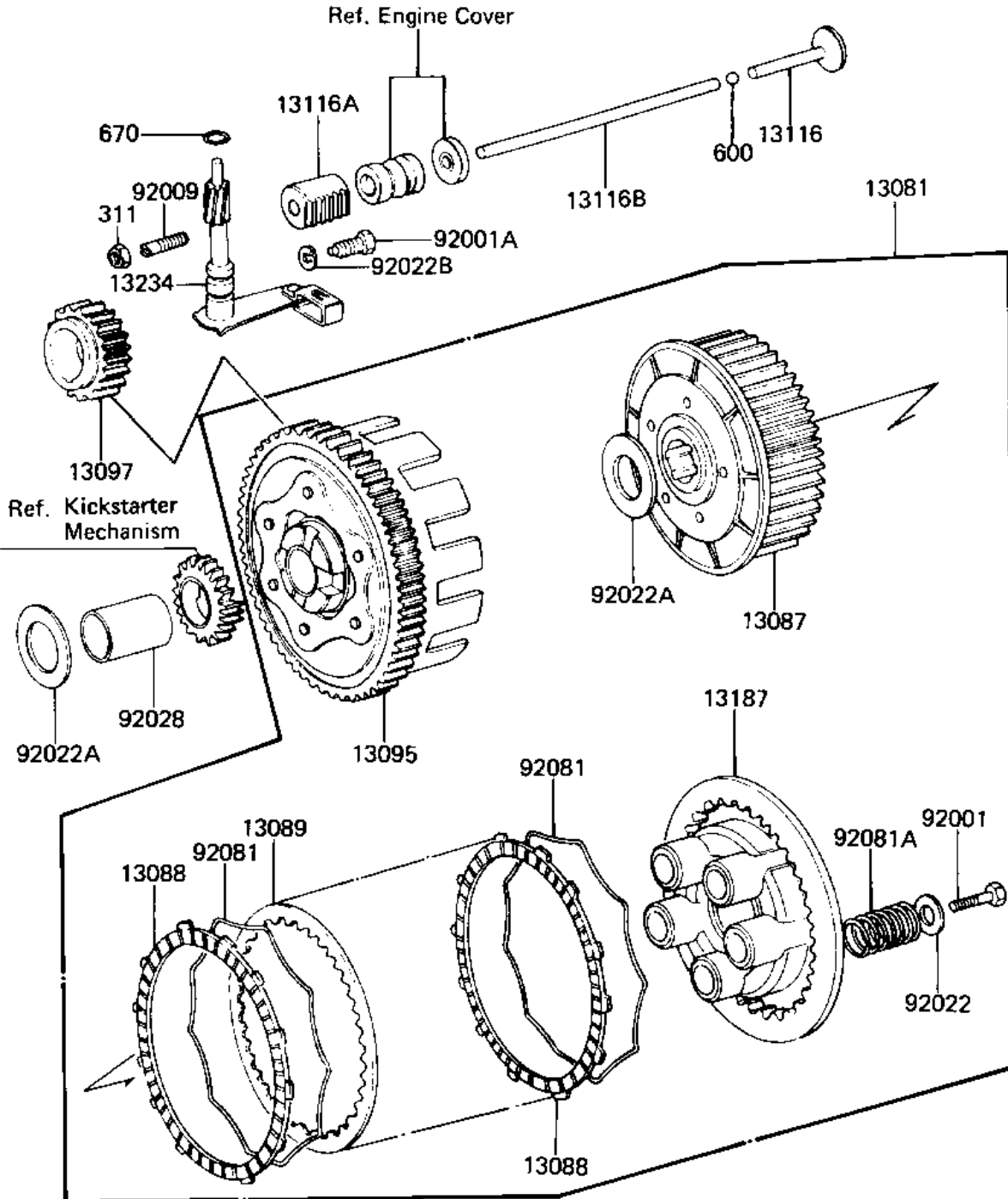

1983 KE125 PARTS LIST

CLUTCH ('82-'83 A9/A10)

ITEM NAME	PART NUMBER	QUANTITY
CLUTCH-ASSY (Ref # 13081)	13081-1053	1
HUB,CLUTCH (Ref # 13087)	13087-038	1
PLATE-FRICTION (Ref # 13088)	13088-1015	1
PLATE CLUTCH STEEL (Ref # 13089)	13089-003	1
HOUSING CLUTCH (Ref # 13095)	13095-1034	1
GEAR,PRIMARY 22T (Ref # 13097)	13097-1040	1
PUSHER-CLTCH SPRG PLT (Ref # 13116)	13116-016	1
ROD,CLTCH RELESE PUSH (Ref # 13116A)	13116-026	1
ROD,CLUTCH PUSH,LONG (Ref # 13116B)	13116-027	1
PLATE-CLUTCH SPRING (Ref # 13187)	13187-004	1
SHAFT ASY,CLTCH RELES (Ref # 13234)	13234-003	1
BOLT,5X18 (Ref # 92001)	92003-078	1
BOLT,CLUTCH RELEASE (Ref # 92001A)	92003-130	1
SCREW,SLOTTED,6X26 (Ref # 92009)	92014-015	1
WASHER-PLAIN,5MM (Ref # 92022)	92022-167	1
WASHER,PLAIN (Ref # 92022A)	92022-270	1
WASHER,LOCK (Ref # 92022B)	92031-009	1
BUSHING,CLUTCH (Ref # 92028)	92028-138	1
RING-CLUTCH STEEL (Ref # 92081)	13229-002	1
SPRING,CLUTCH (Ref # 92081A)	92081-123	1
NUT 6MM (Ref # 311)	311B0600	1
BALL STEEL 7/32' (Ref # 600)	600A0700	1
"0" RING, 10MM (Ref # 670)	670B2010	1