

1981 KE125 PARTS DIAGRAM

HEADLIGHT ('80-'81 A7/A8)

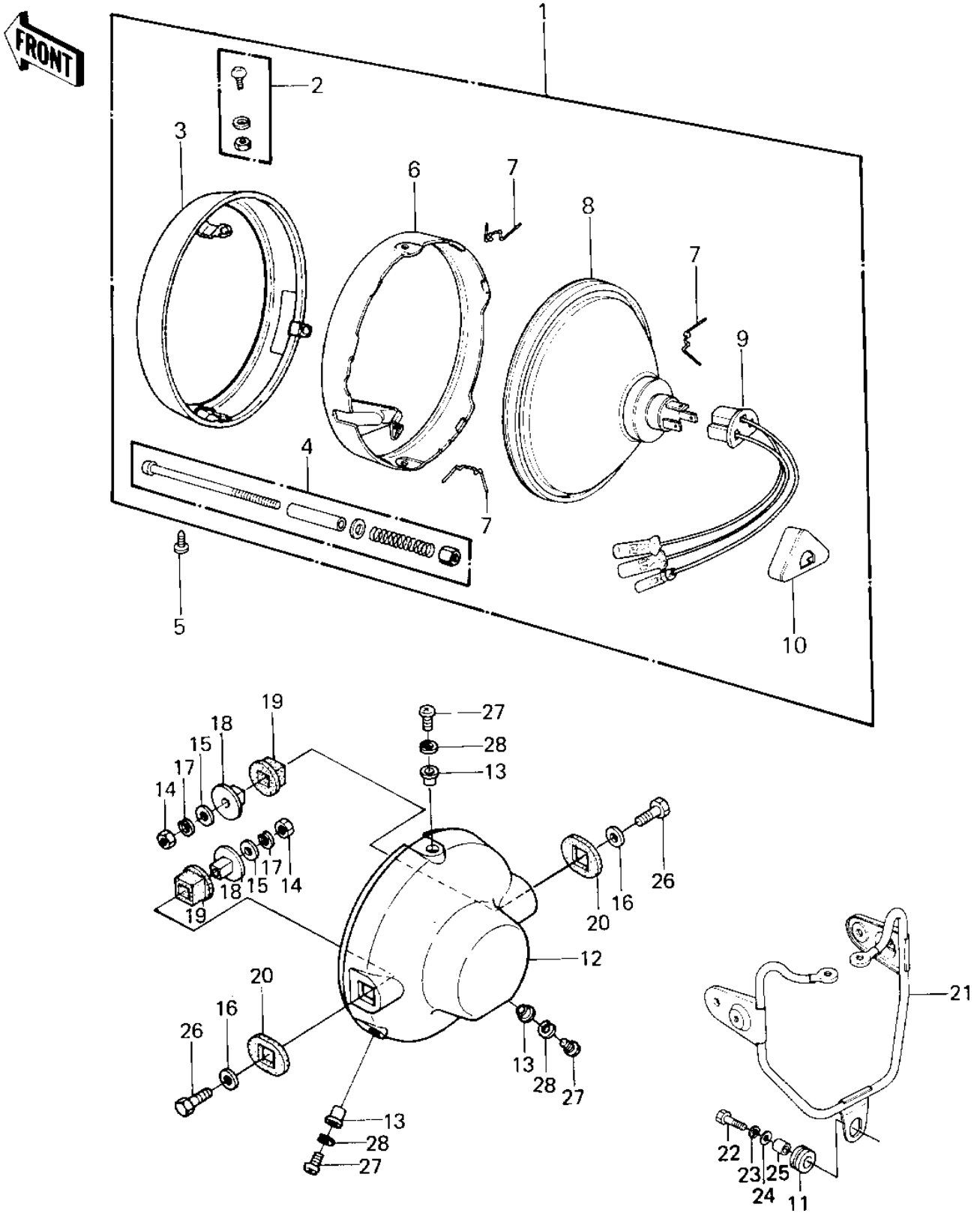

1981 KE125 PARTS LIST

HEADLIGHT ('80-'81 A7/A8)

ITEM NAME	PART NUMBER	QUANTITY
LAMP UNIT,HEAD (Ref # 1)	23004-1030	1
SCREW SET,LENS UNIT (Ref # 2)	23013-007	1
RIM,HEAD LAMP (Ref # 3)	23006-1004	1
SCREW ASSY,FOCUS AJST (Ref # 4)	23013-5001	1
SCREW PAN HEAD 5X12 (Ref # 5)	220B0512	2
RETAINER,SEALED BEAM (Ref # 6)	23072-002	1
CLAMP,HEAD LAMP LENS (Ref # 7)	23009-015	1
SEALED BEAM UNIT (Ref # 8)	23007-055	1
SOCKET ASSY,HD LIGHT (Ref # 9)	23008-044	2
COVER,HD LAMP SOCKET (Ref # 10)	23081-001	1
DAMPER RUBBER,RR FENR (Ref # 11)	92075-209	1
BODY,HEAD LAMP,BLACK (Ref # 12)	23005-1007-6Z	1
WASHER (Ref # 13)	23021-010	1
NUT,8M/M (Ref # 14)	317B0800	1
WASHER PLAIN 8MM (Ref # 15)	411B0800	1
WASHER,PLAIN,8MM (Ref # 16)	411D0800	1
WASHER SPRING 8MM (Ref # 17)	461F0800	1
COLLAR,HEAD LAMP (Ref # 18)	92027-1105	1
DAMPER RUBBER,HD LAMP (Ref # 19)	92075-1077	1
DAMPER RUBBER,HD LAMP (Ref # 20)	92075-1078	1
BRACKET,HEAD LMP BODY (Ref # 21)	11034-1701	1
BOLT-UPSET (Ref # 22)	112G0625	1
WASHER SPRING 6MM (Ref # 23)	461F0600	1
WASHER 6.5X20X1.6T (Ref # 24)	92022-125	1
COLLAR (Ref # 25)	92027-241	1
BOLT-SMALL,8X32 (Ref # 26)	114N0832	1
WASHER SPRING 5MM (Ref # 28)	461F0500	1