

1981 KE125 PARTS DIAGRAM

SEAT ('80-'81 A7/A8)

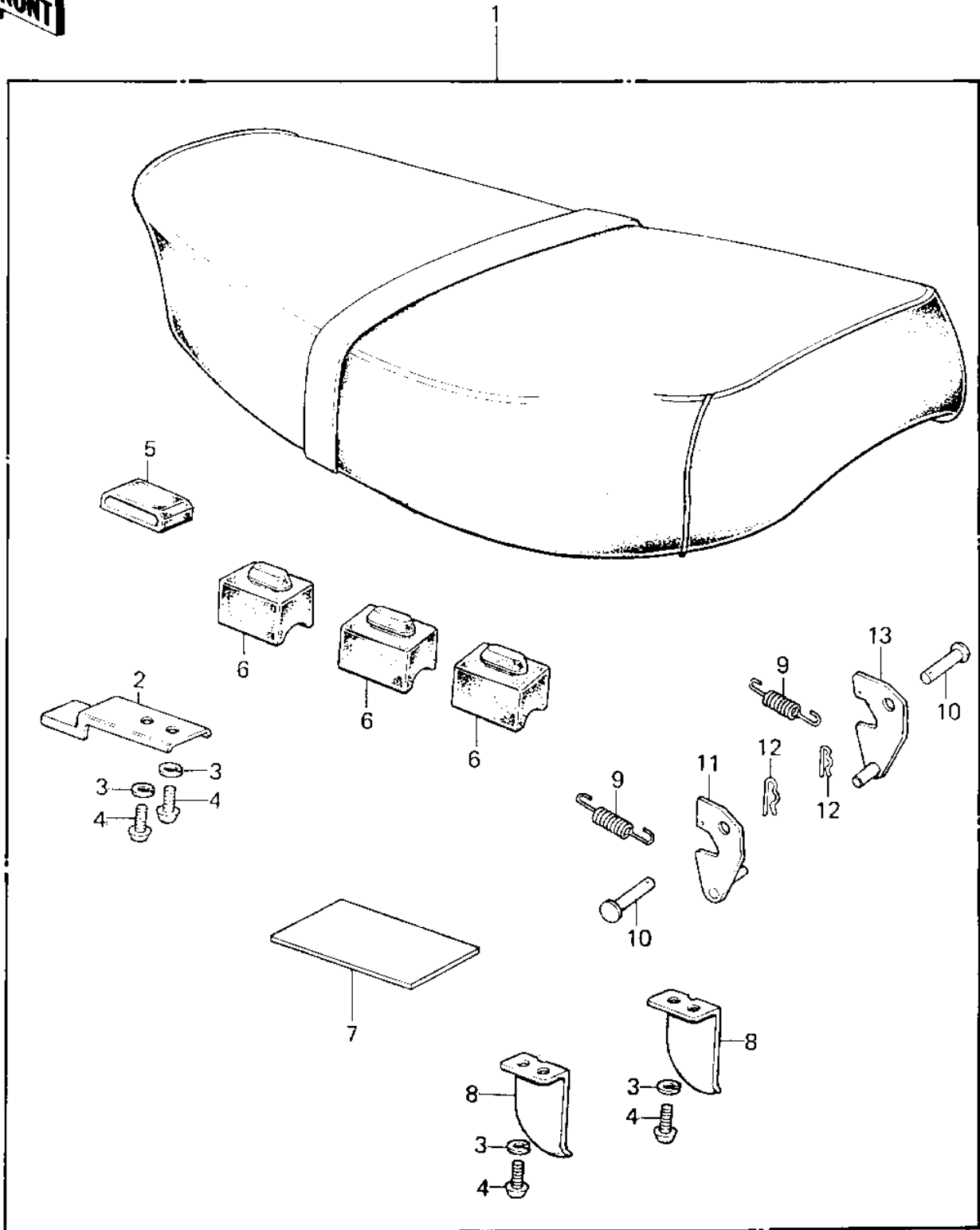

1981 KE125 PARTS LIST

SEAT ('80-'81 A7/A8)

ITEM NAME	PART NUMBER	QUANTITY
SEAT-ASSY (Ref # 1)	53001-1081	1
BRACKET,DUAL SEAT (Ref # 2)	53032-005	1
WASHER SPRING 6MM (Ref # 3)	461F0600	1
SCREW PAN HEAD 6X14 (Ref # 4)	220B0614	1
DAMPER RUBBER,SEAT (Ref # 5)	92075-219	1
DAMPER RUBBER,SEAT (Ref # 6)	92075-216	1
DAMPER RUBBER,BATTERY (Ref # 7)	92075-224	1
STOPPER,SEAT (Ref # 8)	53059-001	1
SPRING,HOOK (Ref # 9)	53012-013	1
PIN DUAL SEAT PIVOT (Ref # 10)	53011-001	1
HOOK,SEAT,L.H (Ref # 11)	53008-028	1
PIN,SNAP (Ref # 12)	554A0600	1
HOOK,SEAT,R.H (Ref # 13)	53008-029	1