

# 1981 KE125 PARTS DIAGRAM

WHEELS/TIRES ('80-81 A7/A8)

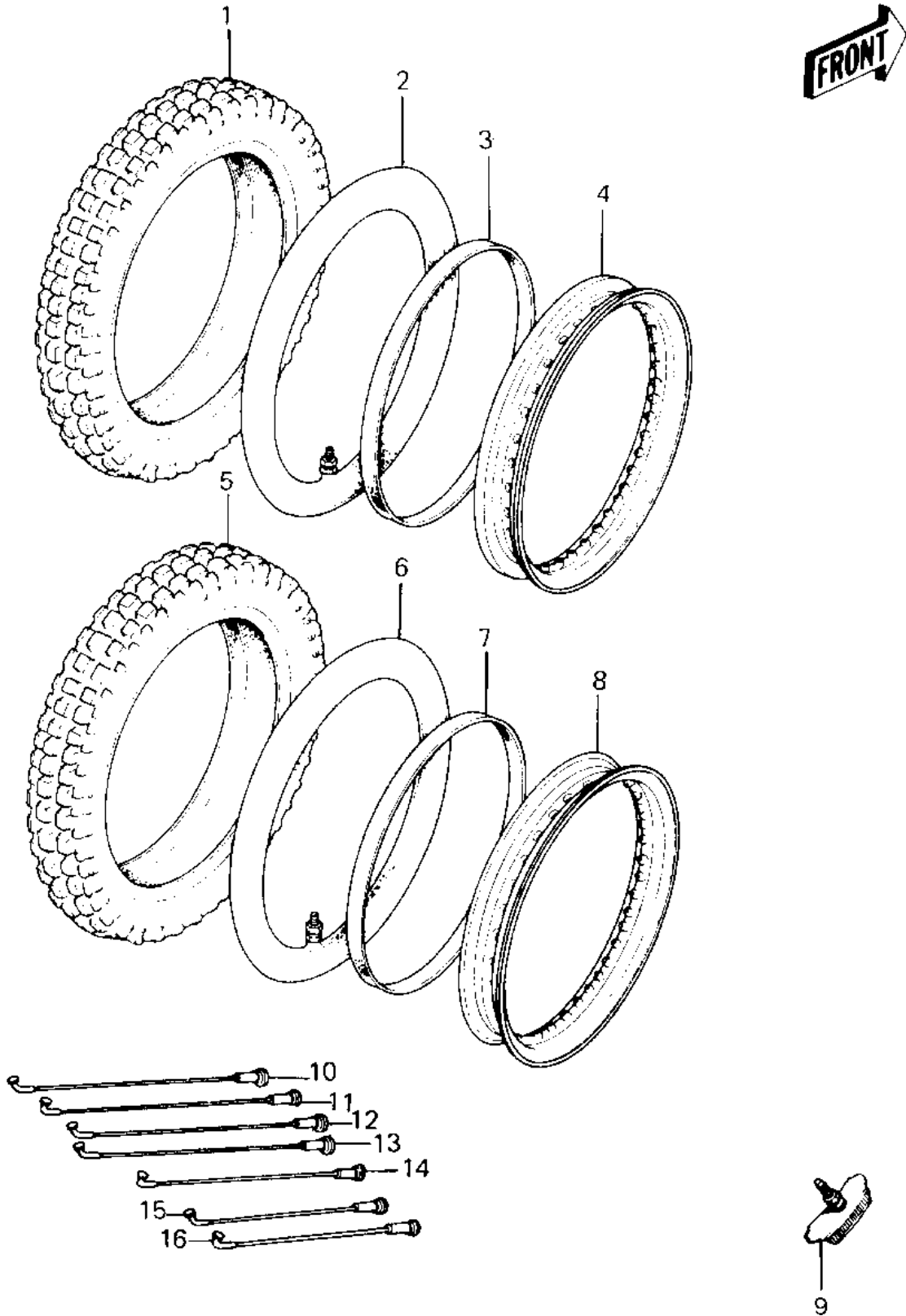

# 1981 KE125 PARTS LIST

WHEELS/TIRES ('80-81 A7/A8)

ITEM NAME	PART NUMBER	QUANTITY
TIRE 275-21 Y965 F (Ref # 1)	41002-1215	1
TUBE,2.75/3.70-21 (Ref # 2)	41022-1021	1
BAND,RIM,3.00-21 (Ref # 3)	41023-1001	1
RIM,1.60AX21 (Ref # 4)	41025-078	1
TIRE 350-18 Y962 R (Ref # 5)	41002-1216	1
UNAVAILABLE IN PRICE BOOK (Ref # 6)	41022-1004	1
BAND RIM (Ref # 7)	41023-001	1
RIM 1.85BX18W (Ref # 8)	41025-044	1
PROTECTOR-BEAD 1.85B (Ref # 9)	41024-007	1
SPOKE-ASY,FR INNER (Ref # 10)	41027-068	1
SPOKE-ASY FR OUTER (Ref # 11)	41028-068	1
SPOKE-ASY,FR (Ref # 12)	41027-069	1
SPOKE-ASY,RR INNER L (Ref # 13)	41027-070	1
SPOKE-ASY RR OUTER L (Ref # 14)	41028-069	1
SPOKE-ASY,RR INNER R (Ref # 15)	41027-071	1
SPOKE-ASY RR OUTER R (Ref # 16)	41028-070	1