

1982 LTD Belt PARTS DIAGRAM

SWING ARM/SHOCK ABSORBERS ('81-'83 D2/D3)

F2140 0043

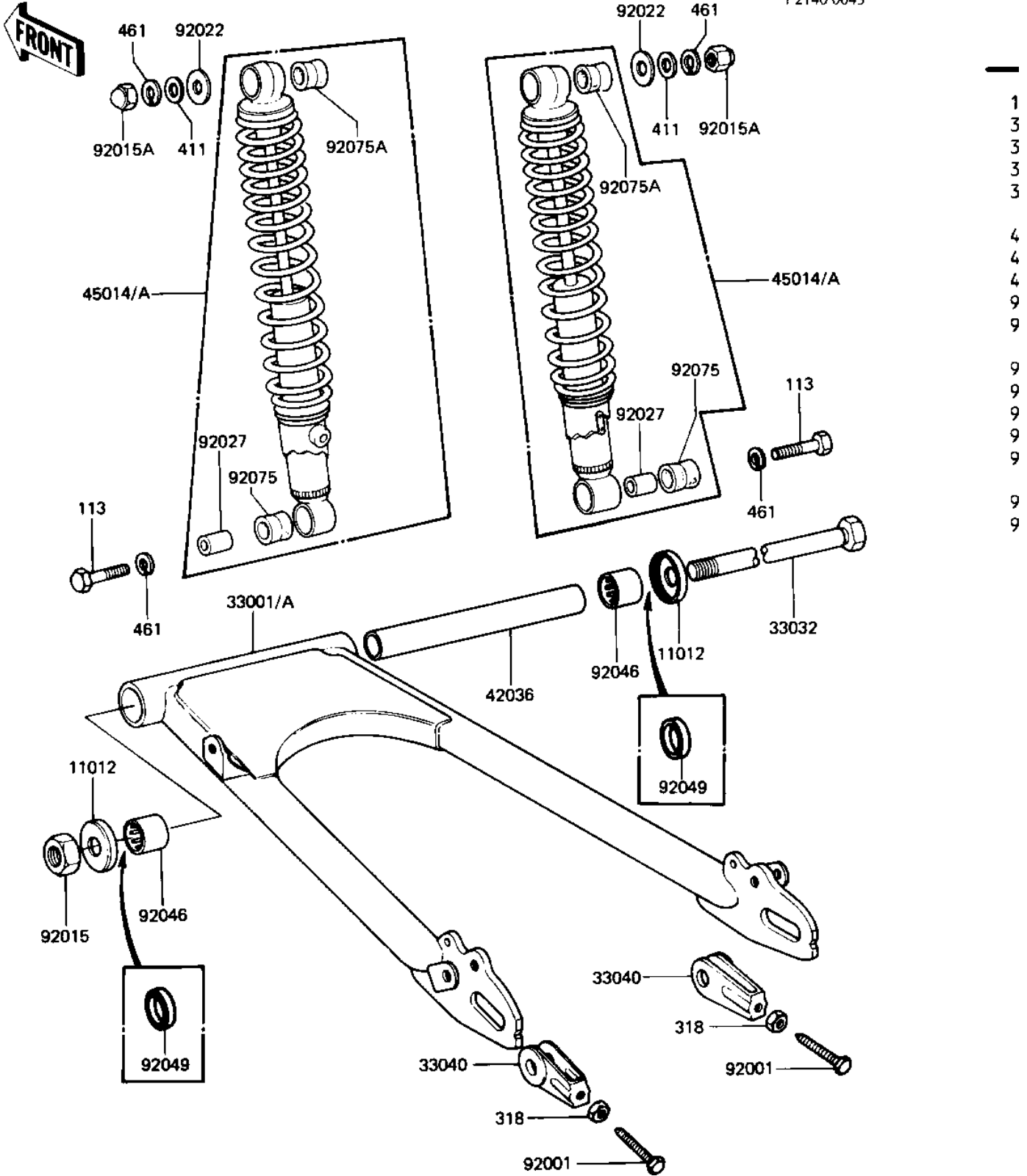

1982 LTD Belt PARTS LIST

SWING ARM/SHOCK ABSORBERS ('81-'83 D2/D3)

ITEM NAME	PART NUMBER	QUANTITY
CAP,SWING ARM (Ref # 11012)	11012-1029	2
ARM-COMP-SWING (Ref # 33001A)	33001-1112	1
SHAFT,SWING ARM PIVOT (Ref # 33032)	33032-1011	1
ADJUSTER-CHAIN (Ref # 33040)	33040-043	2
SLEEVE,SWING ARM (Ref # 42036)	42036-1017	1
SHOCK ABSORBER,RR (Ref # 45014A)	45014-1217	2
BOLT,8X50 (Ref # 92001)	92001-1399	2
NUT-LOCK,14MM (Ref # 92015)	92019-011	1
NUT, CAP, 10 MM (Ref # 92015A)	92020-003	2
WASHER-PLN,10X22X3.2 (Ref # 92022)	92022-176	2
BUSHING,SHOCK ABSORB (Ref # 92027)	45016-008	2
BEARING-NEEDLE,HK2216 (Ref # 92046)	92046-1115	2
OIL SEAL,MHA22284 (Ref # 92049)	92049-1059	2
BUSHING, SHCK ABS RUB (Ref # 92075)	45017-012	2
BUSHING,SHCK ABS RUB (Ref # 92075A)	45017-015	2
BOLT HEX HEAD 10X35 (Ref # 113)	113N1035	2
NUT 8MM (Ref # 318)	318B0800	2
WASHER PLAIN 10MM (Ref # 411)	411B1000	2
WASHER SPRING 10MM (Ref # 461)	461F1000	4