

1982 LTD Belt PARTS DIAGRAM

CAMSHAFT/CHAIN/TENSIONER ('81-'83 D2/D3)

E1230-0001

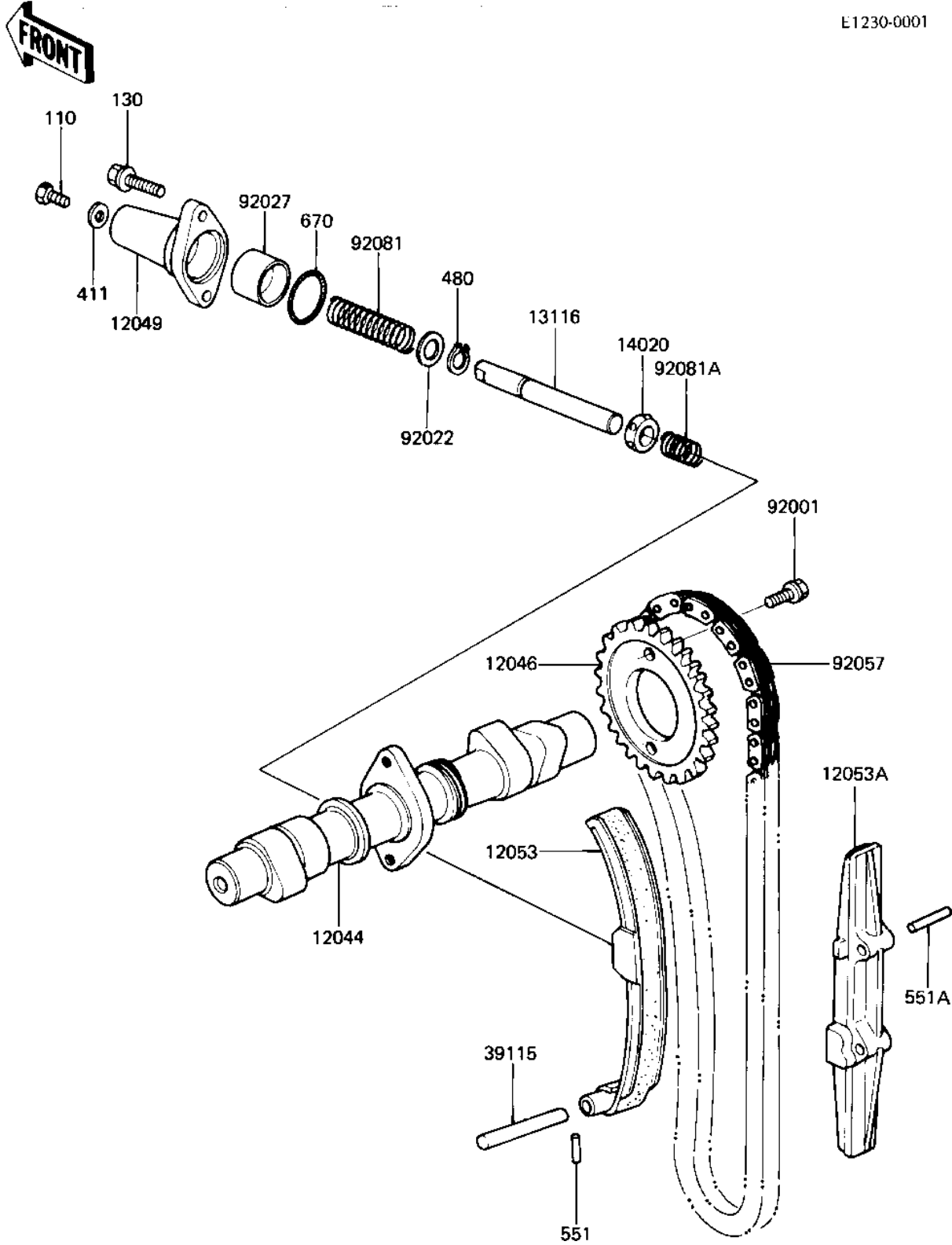

1982 LTD Belt PARTS LIST

CAMSHAFT/CHAIN/TENSIONER ('81-'83 D2/D3)

ITEM NAME	PART NUMBER	QUANTITY
CAMSHAFT,VALVE (Ref # 12044)	12044-5001	1
SPROCKET,CAM,46T (Ref # 12046)	12046-1022	1
BRACKET,TENSIONER (Ref # 12049)	12049-1010	1
GUIDE,CHAIN,FRONT (Ref # 12053)	12053-1041	1
GUIDE,CHAIN,REAR (Ref # 12053A)	12053-1042	1
ROD,PUSH,TENSIONER (Ref # 13116)	13116-1022	1
RETAINER (Ref # 14020)	14020-1002	1
SHAFT,CHAIN GUIDE (Ref # 39115)	39115-1001	1
BOLT,SPROCKET FITTING (Ref # 92001)	92003-208	2
WASHER,10X14.5X1.0 (Ref # 92022)	92022-1181	1
COLLAR,TENSIONER (Ref # 92027)	92027-1240	1
CHAIN,CAMSHAFT,114L (Ref # 92057)	92057-1038	1
SPRING,TENSIONER (Ref # 92081)	92081-1206	1
SPRING,TENSIONER (Ref # 92081A)	92081-1207	1
BOLT-UPSET 6X14 (Ref # 110)	112B0614	1
BOLT,FLANGED,6X20 (Ref # 130)	130G0620	2
WASHER PLAIN 6MM (Ref # 411)	411B0600	1
CIRCLIP,10M/M (Ref # 480)	480J1000	1
PIN,DOWEL,3X25 (Ref # 551)	551A0325	1
PIN,DOWEL,5X32 (Ref # 511A)	551A0532	2
"O" RING,21MM (Ref # 670)	670B2021	1