

2004 Ultra 150 PARTS DIAGRAM

Crankcase

E1411

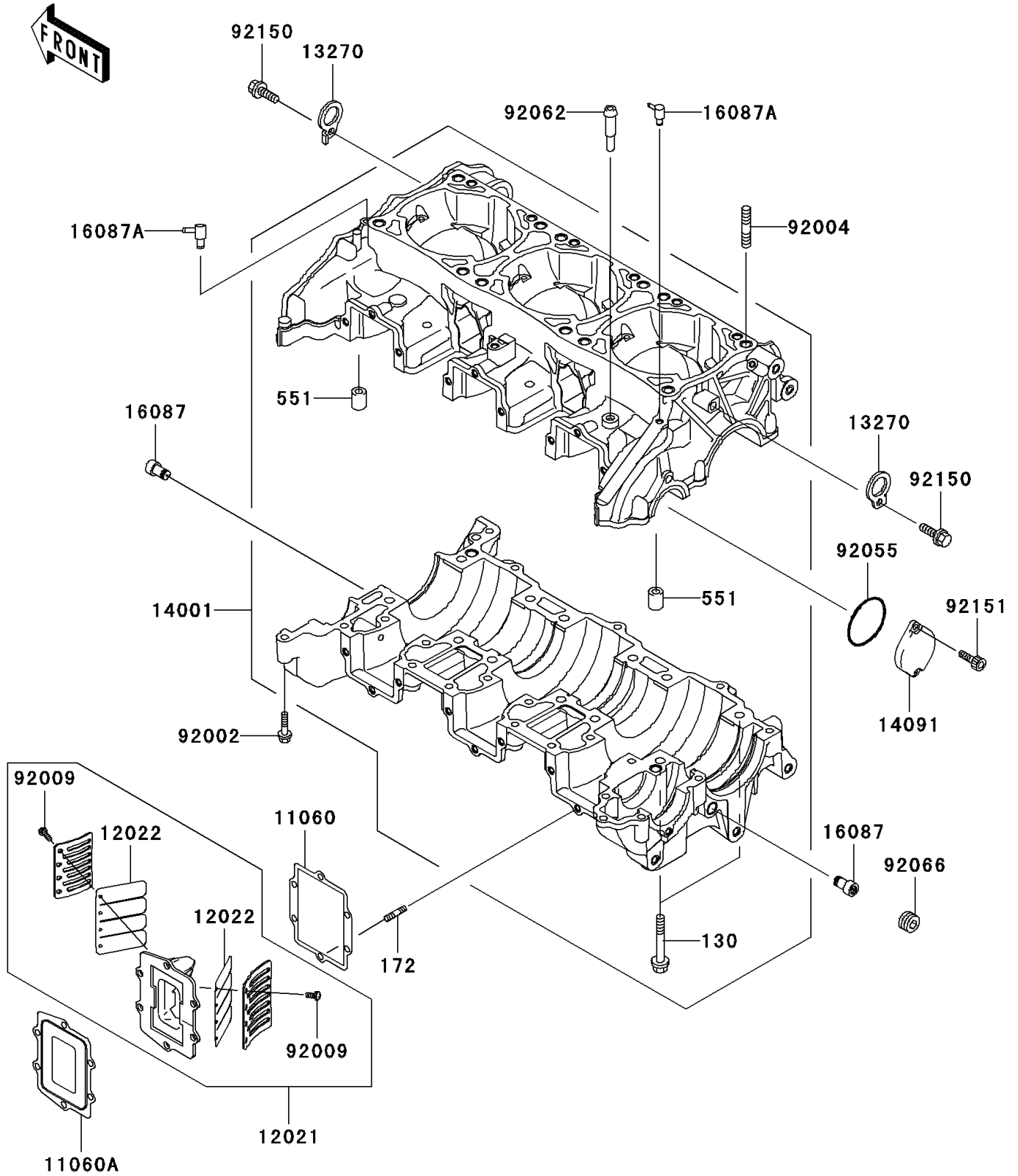

2004 Ultra 150 PARTS LIST

Crankcase

ITEM NAME	PART NUMBER	QUANTITY
BOLT-FLANGED (Ref # 130)	130Z0855	1
BOLT-STUD (Ref # 172)	172R0620	1
PIN-DOWEL (Ref # 551)	551R1012	1
GASKET, REED VALVE (Ref # 11060)	11060-3717	1
GASKET, REED VALVE (Ref # 11060A)	11060-3757	1
VALVE-ASSY-REED (Ref # 12021)	12021-3711	1
VALVE-REED (Ref # 12022)	12022-3709	1
PLATE (Ref # 13270)	13270-3899	1
SET-CRANKCASE (Ref # 14001)	14001-5377	1
COVER, BALANCER (Ref # 14091)	14091-3736	1
VALVE-CHECK (Ref # 16087)	16087-3707	1
VALVE-CHECK (Ref # 16087A)	16087-3708	1
BOLT, 6X40 (Ref # 92002)	92002-3716	1
STUD, 10X35 (Ref # 92004)	92004-3731	1
SCREW, 3X6 (Ref # 92009)	92009-1371	1
RING-O (Ref # 92055)	92055-1397	1
NOZZLE (Ref # 92062)	92062-3705	1
PLUG, PT1/4X8.9 (Ref # 92066)	92066-3765	1
BOLT, 6X18 (Ref # 92150)	92150-3729	1
BOLT (Ref # 92151)	92151-3779	1