

1980 LTD PARTS DIAGRAM

SPECIAL SERVICE TOOLS "A" ('80-'81 C1/C2)

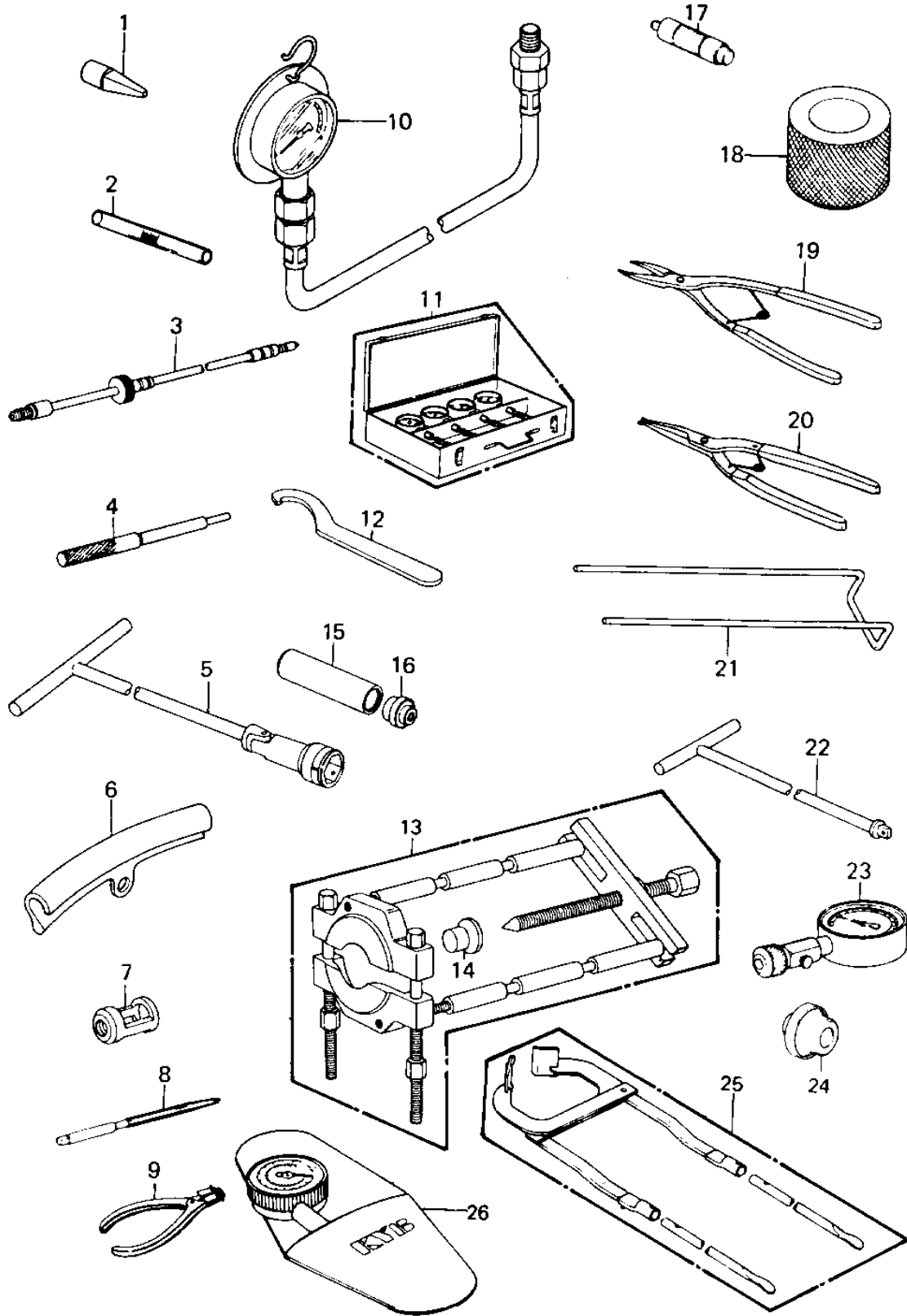

1980 LTD PARTS LIST

SPECIAL SERVICE TOOLS "A" ('80-'81 C1/G2)

ITEM NAME	PART NUMBER	QUANTITY
ADAPTER,FORK CYL HLDR (Ref # 1)	57001-1011	1
GAUGE-FUEL LEVEL (Ref # 2)	57001-1017	1
GAUGE-CMP ADPTR 12MM (Ref # 3)	57001-1018	1
ARBOR,VALVE GUIDE (Ref # 4)	57001-1021	1
WRENCH,SPARK PLUG (Ref # 5)	57001-1024	1
PROTECTOR-BEAD (Ref # 6)	57001-1063	1
ADAPTER,VALVE SPRING (Ref # 7)	57001-1078	1
REAMER-VALVE GUIDE (Ref # 8)	57001-1079	1
PLIERS-PISTON RING (Ref # 9)	57001-115	1
*** N.L.A.*** (Canada) (Ref # 10)	57001-125	1
*** N.L.A.*** (Canada) (Ref # 11)	57001-127	1
57001-1100 (Canada) (Ref # 12)	57001-134	1
PULLER,STEM BEARING (Ref # 13)	57001-135	1
ADAPTER,STEM BEARING (Ref # 14)	57001-136	1
DRIVER,STEM BEARING (Ref # 15)	57001-137	1
57001-1129 (Canada) (Ref # 16)	57001-138	1
*** N.L.A.*** (Canada) (Ref # 17)	57001-139	1
*** N.L.A.*** (Canada) (Ref # 18)	57001-141	1
PLIERS,CIRCLIP,INSIDE (Ref # 19)	57001-143	1
PLIERS,CIRCLIP,OUTSID (Ref # 20)	57001-144	1
57001-1336 (Canada) (Ref # 21)	57001-149	1
HANDLE,FORK CLY HOLDR (Ref # 22)	57001-183	1
GAUGE COMPRESSION (Ref # 23)	57001-221	1
*** N.L.A.*** (Canada) (Ref # 24)	57001-296	1
BREAKER-BEAD,ASSY (Ref # 25)	57001-1072	1
GAUGE,AIR (Ref # 26)	52005-1003	1