

# 1981 KZ550-A2 PARTS DIAGRAM

STARTER MOTOR/STARTER CLUTCH ('80-'81 A1)

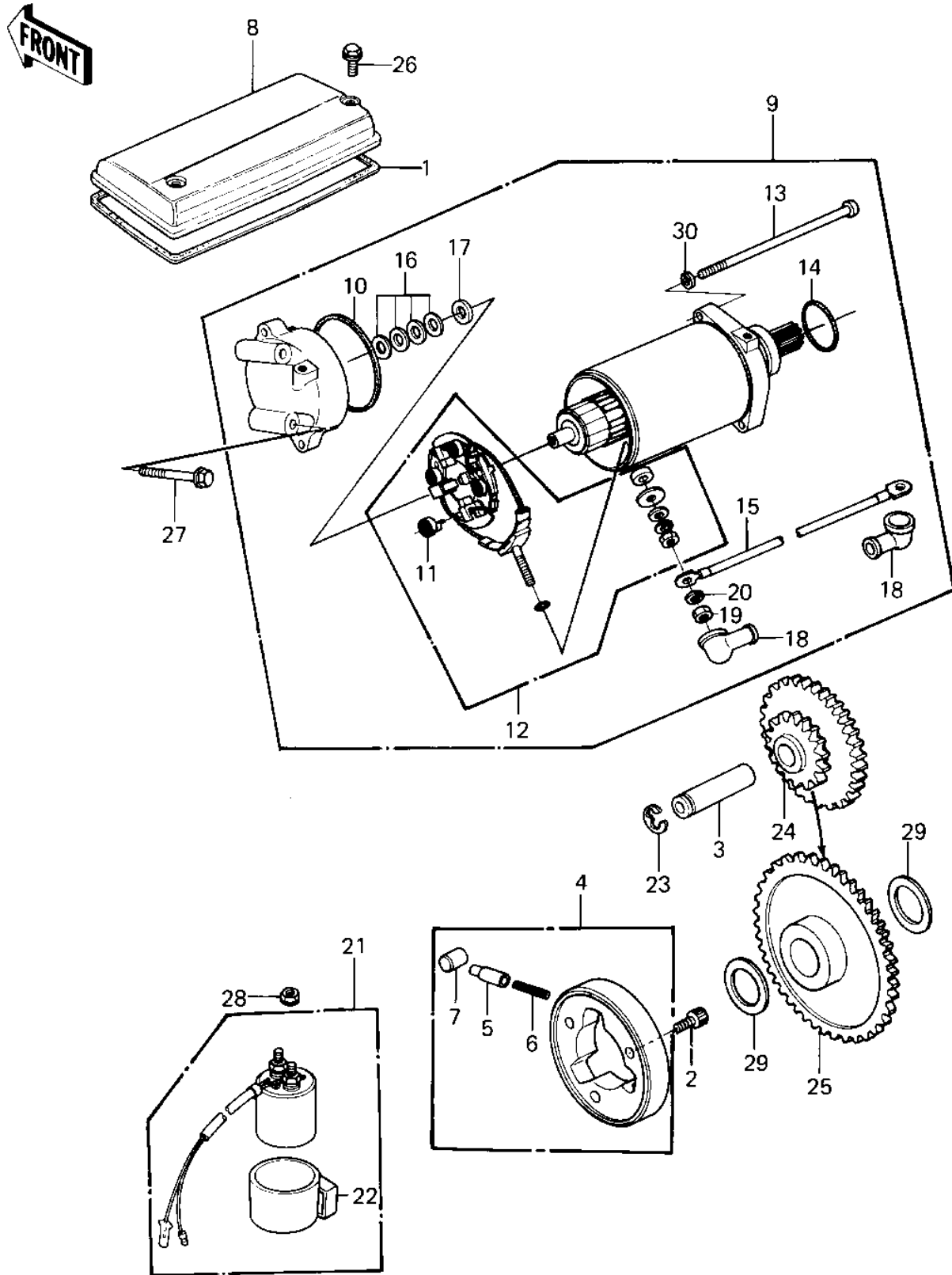

# 1981 KZ550-A2 PARTS LIST

## STARTER MOTOR/STARTER CLUTCH ('80-'81 A1)

ITEM NAME	PART NUMBER	QUANTITY
GASKET,STARTER COVER (Ref # 1)	11009-1069	1
BOLT,SOCKET,8X10 (Ref # 2)	92001-1424	3
BOLT,SOCKET,8X10 (Ref # 2)	92001-1424	3
SHAFT,IDLE GEAR (Ref # 3)	13107-1006	1
CLUTCH ASSY,ONEWAY (Ref # 4)	13193-1002	1
PIN (Ref # 5)	92043-132	3
SPRING,COIL (Ref # 6)	92081-159	3
ROLLER (Ref # 7)	92122-006	3
COVER,STARTER MOTOR (Ref # 8)	14025-1050	1
STARTER-ELECTRIC (Ref # 9)	21163-1031	1
"0" RING,STARTER MOTR (Ref # 10)	92055-1086	1
SPRING,CARBON BRUSH (Ref # 11)	21040-1002	4
BRUSH SET,CARBON (Ref # 12)	21039-1005	1
SCREW,PAN HEAD,6X110 (Ref # 13)	21015-005	2
"0" RING,STARTING MTR (Ref # 14)	21027-004	1
WIRE,STARTER MOTOR (Ref # 15)	26011-1073	1
WASHER,THRUST,0.2T (Ref # 16)	21025-011	4
WASHER,THRUST,0.8T (Ref # 17)	92022-1132	1
GROMMET,CORD (Ref # 18)	21017-017	2
NUT 6MM (Ref # 19)	312B0600	1
WASHER SPRING 6MM (Ref # 20)	461F0600	1
SWITCH ASSY,MAGNETIC (Ref # 21)	21164-005	1
DAMPER MAG SWITCH SHK (Ref # 22)	21064-002	1
CIRCLIP 12MM (Ref # 23)	482K0200	1
GEAR,STARTER IDLE (Ref # 24)	59051-1011	1
GEAR,ONEWAY CLUTCH (Ref # 25)	16085-1030	1
BOLT,6X10 (Ref # 26)	92001-1151	2
BOLT,HEX HEAD,6X54 (Ref # 27)	92003-110	2
NUT-6MM (Ref # 28)	92015-1078	2

# 1981 KZ550-A2 PARTS LIST

STARTER MOTOR/STARTER CLUTCH ('80-'81 A1)

ITEM NAME	PART NUMBER	QUANTITY
SPACER,25X36X3.2 (Ref # 29)	92026-1025	2
WASHER SPRING 5MM (Ref # 30)	461F0500	2