

1981 KZ550-A2 PARTS DIAGRAM

BREATHER COVER/OIL PAN ('80-'81 A1/A2)

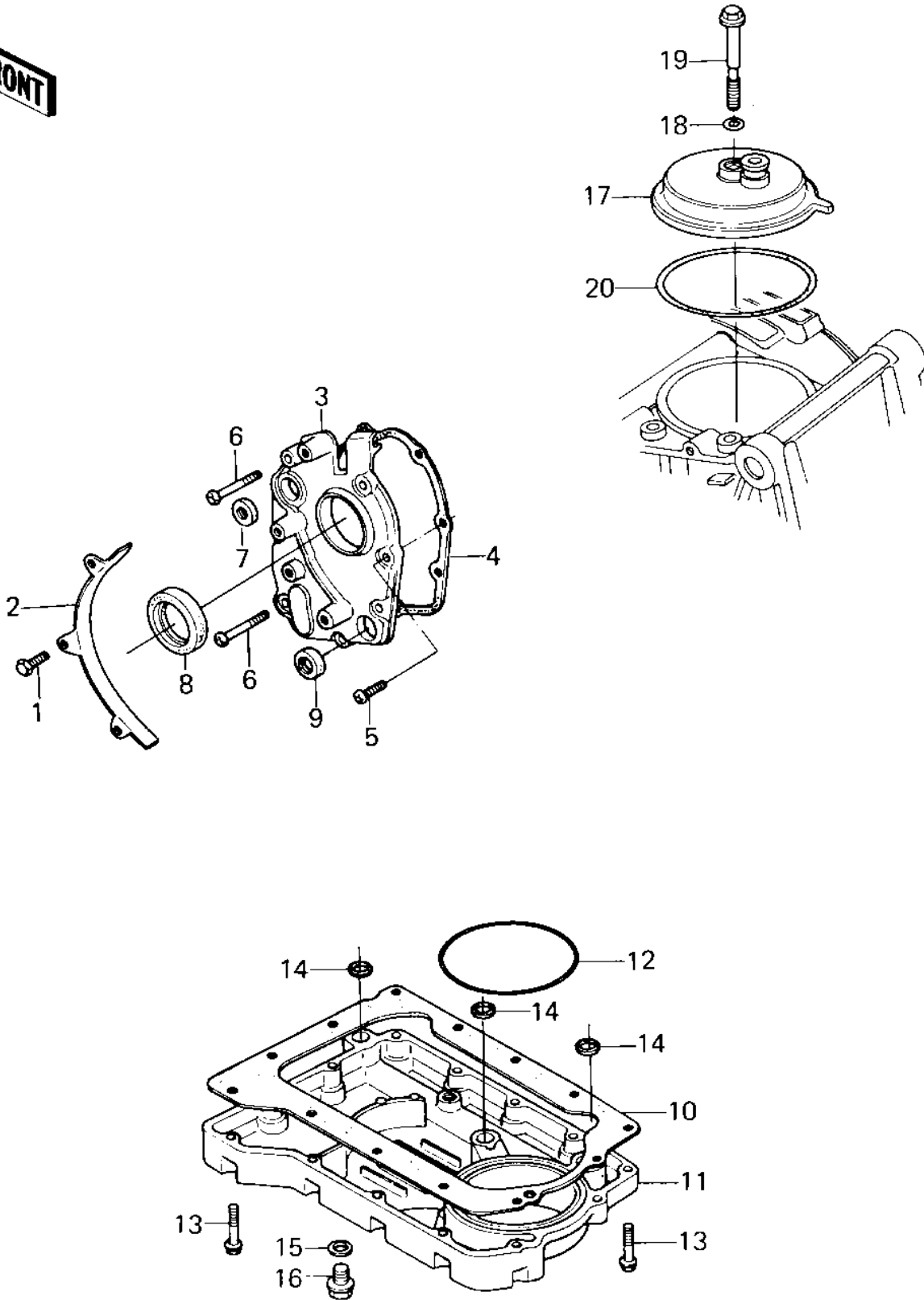

1981 KZ550-A2 PARTS LIST

BREATHER COVER/OIL PAN ('80-'81 A1/A2)

ITEM NAME	PART NUMBER	QUANTITY
BOLT-UPSET 6X14 (Ref # 1)	112B0614	3
GUIDE,CHAIN (Ref # 2)	12053-1006	1
COVER,MISSION (Ref # 3)	14024-011	1
GASKET,TRANSMISSION C (Ref # 4)	11060-1056	1
SCREW PAN HEAD 6X20 (Ref # 5)	220B0620	5
SCREW PAN HEAD 6X40 (Ref # 6)	220B0640	2
OIL SEAL,SD-8187 (Ref # 7)	92049-1017	1
OIL SEAL SC325210 (Ref # 8)	92050-024	1
OIL SEAL,TB13225.5 (Ref # 9)	92051-005	1
GASKET,OIL PAN (Ref # 10)	11060-1057	1
PAN,OIL (Ref # 11)	49034-1002	1
"O" RING,90MM (Ref # 12)	671B2590	1
BOLT,FLANGED,6X25 (Ref # 13)	130G0625	13
"O" RING (Ref # 14)	92055-077	3
GASKET,DRIN PLUG (Ref # 15)	92065-097	1
PLUG,OIL DRAIN,12X15 (Ref # 16)	92066-1174	1
BODY-BREATHER (Ref # 17)	14070-1008	1
"O" RING,8MM (Ref # 18)	670B1508	1
BOLT,HEX HEAD,8X72 (Ref # 19)	92003-107	1
"O" RING,91MM (Ref # 20)	92055-052	1