

2001 Ultra 150 PARTS DIAGRAM

Meters

F3179

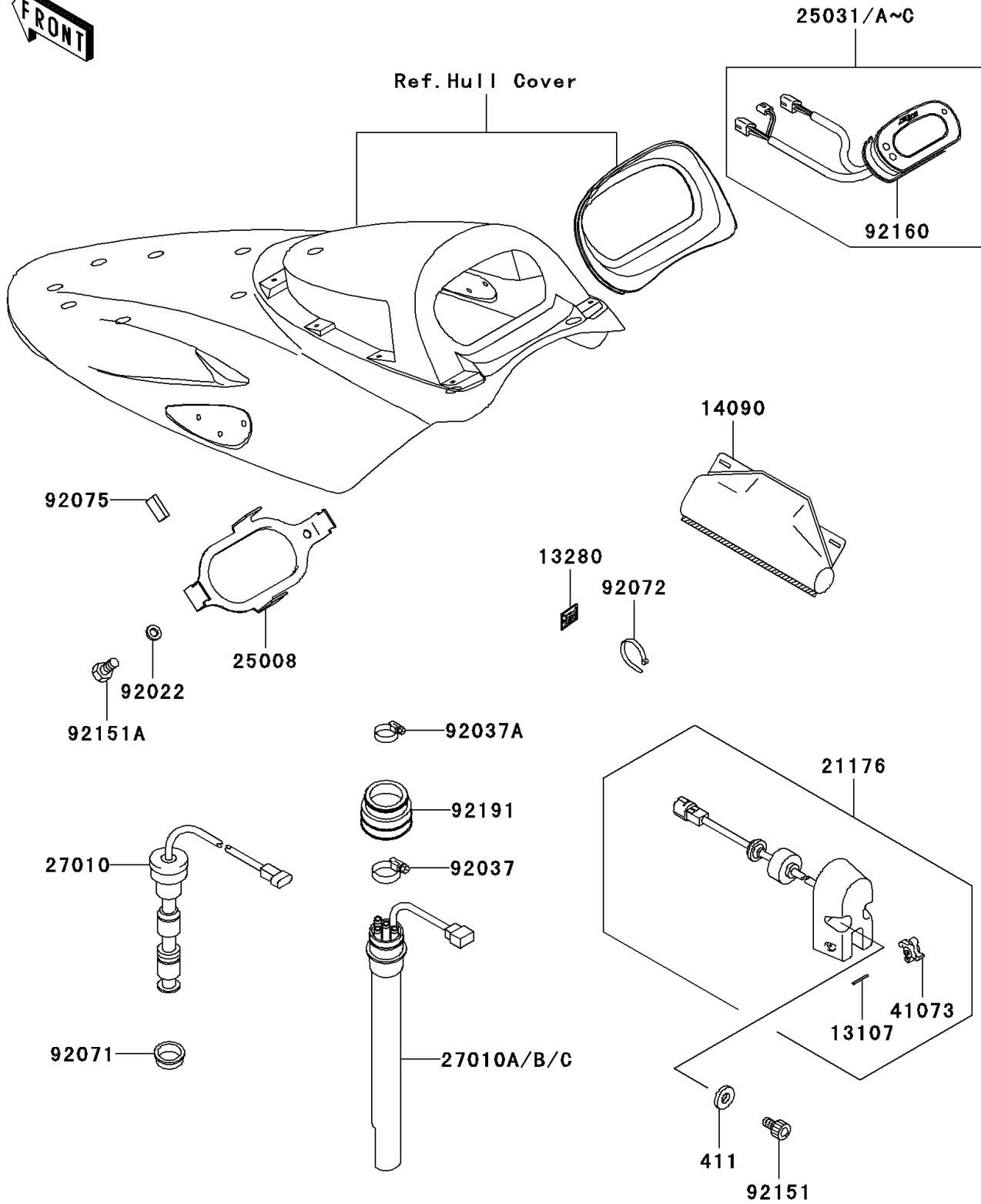

2001 Ultra 150 PARTS LIST

Meters

ITEM NAME	PART NUMBER	QUANTITY
WASHER-PLAIN,6MM (Ref # 411)	411S0600	2
SHAFT (Ref # 13107)	13107-3754	1
COVER,COUPLER (Ref # 14090)	14090-1611	1
SENSOR,SPEEDOMETER,J.WHITE (Ref # 21176)	21176-3732-8U	1
BRACKET-METER (Ref # 25008)	25008-3709	1
SWITCH,OIL LEVEL (Ref # 27010)	27010-3765	1
SWITCH,FUEL LEVEL (Ref # 27010B)	27010-3769	1
WHEEL-ASSY,PADDLE (Ref # 41073)	41073-3701	1
WASHER,5X16X1.5 (Ref # 92022)	92022-3041	2
CLAMP (Ref # 92037)	92037-3009	1
CLAMP (Ref # 92037A)	92037-3738	1
GROMMET (Ref # 92071)	92071-3824	1
BAND,L=201 (Ref # 92072)	92072-3778	2
DAMPER (Ref # 92075)	92075-1446	4
BOLT,SOCKET,6X10 (Ref # 92151)	92151-3704	2
BOLT,5X10 (Ref # 92151A)	92151-3707	2
DAMPER,METER (Ref # 92160)	92160-3881	1
TUBE (Ref # 92191)	92191-3832	1
HOLDER (Ref # 13280)	13280-3706	1
HOLDER (Ref # 13280)	13280-3706	2
METER-ASSY,MILE (Ref # 25031B)	25031-3718	1
METER-ASSY,KM (Ref # 25031C)	25031-3719	1