

1999 Ultra 150 PARTS DIAGRAM

Handlebar

F3172

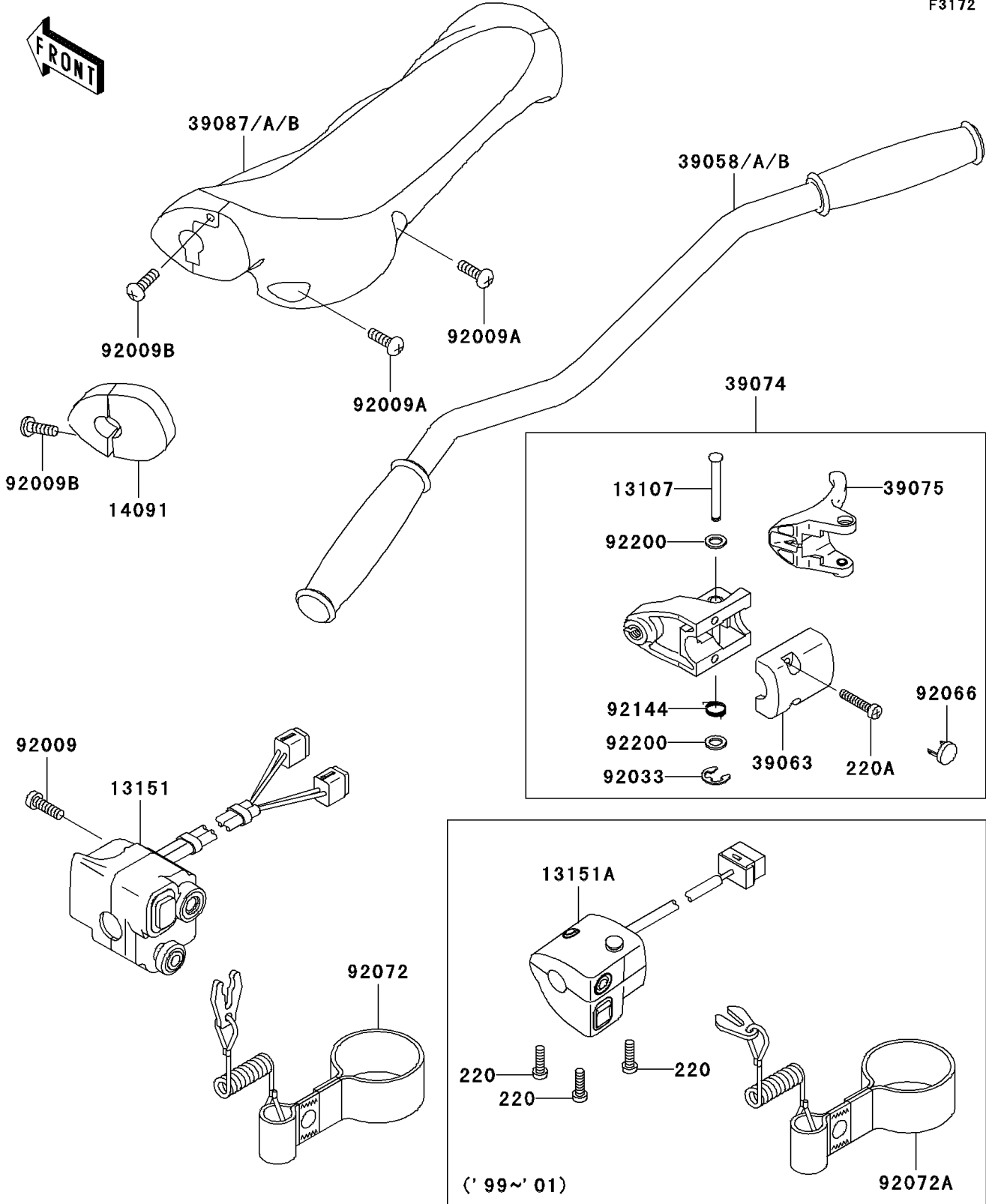

1999 Ultra 150 PARTS LIST

Handlebar

ITEM NAME	PART NUMBER	QUANTITY
SCREW-PAN-CROS,5X30 (Ref # 220)	220R0530	3
SCREW-PAN-CROSS (Ref # 220A)	220R0635	2
SHAFT (Ref # 13107)	13107-3766	1
SWITCH-COMP,STOPSTART&TRIM,BLK (Ref # 13151A)	13151-3749-6Z	1
HANDLE-COMP,F.RED (Ref # 39058)	39058-3725-6L	1
HOUSING-CONTROL (Ref # 39063)	39063-3724	1
LEVER-ASSY-THROTTLE (Ref # 39074)	39074-3722	1
LEVER-THROTTLE (Ref # 39075)	39075-3715	1
PAD-HANDLE,F.SILVER (Ref # 39087A)	39087-3724-MN	1
SCREW,6X14 (Ref # 92009A)	92009-3851	9
SCREW (Ref # 92009B)	92009-3853	2
RING-SNAP (Ref # 92033)	92033-3723	1
PLUG (Ref # 92066)	92066-3760	2
BAND,TETHER SWITCH (Ref # 92072A)	92072-3830	1
SPRING (Ref # 92144)	92144-3749	1
WASHER (Ref # 92200)	92200-3738	2