

1982 LTD PARTS DIAGRAM

BREATHER COVER/OIL PAN ('81-'83 H2/H3/H4)

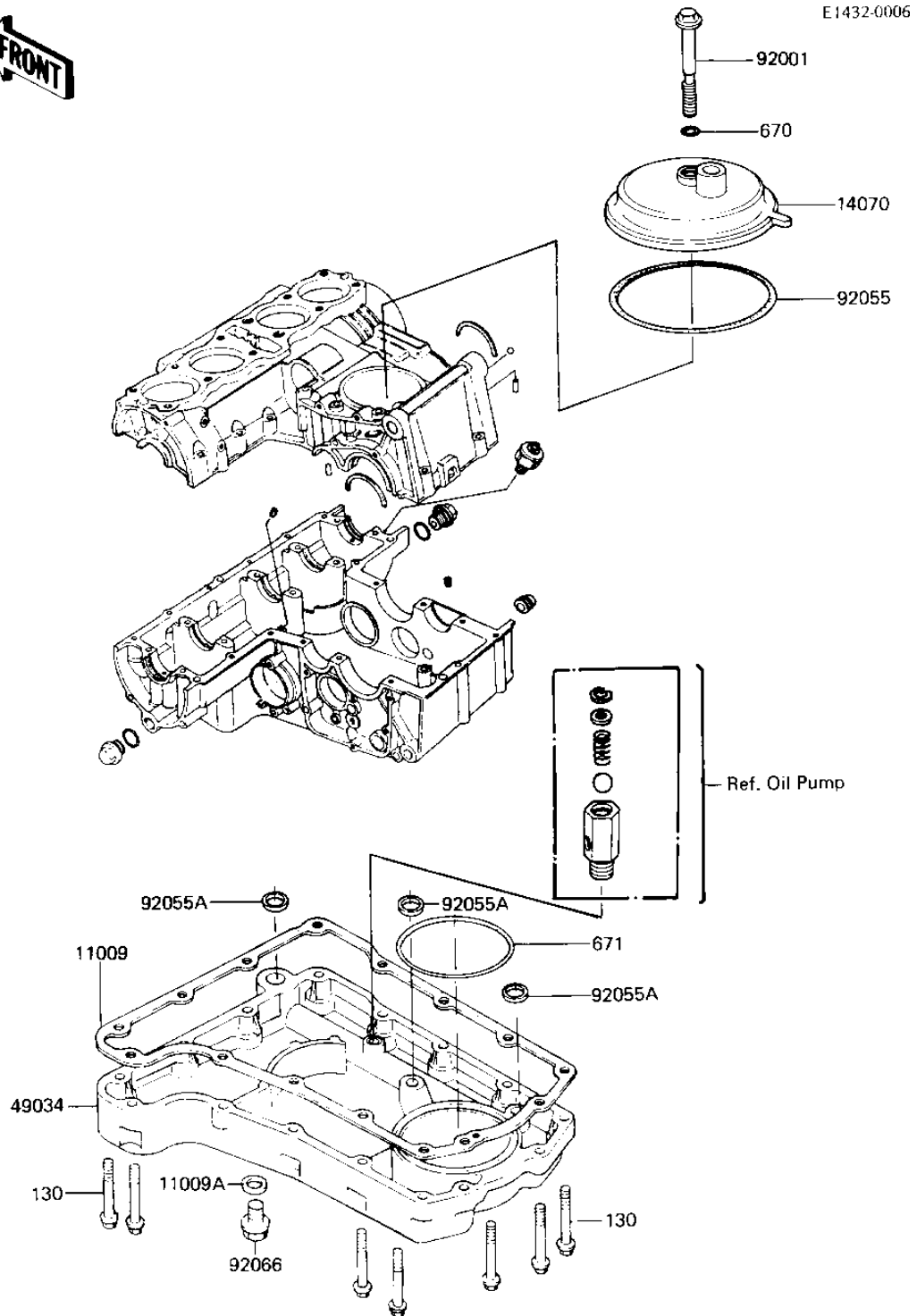

1982 LTD PARTS LIST

BREATHER COVER/OIL PAN ('81-'83 H2/H3/H4)

ITEM NAME	PART NUMBER	QUANTITY
GASKET,OIL PAN (Ref # 11009)	11009-1983	1
GASKET,DRIN PLUG (Ref # 11009A)	92065-097	1
BODY-BREATHER (Ref # 14070)	14070-1008	1
PAN-OIL (Ref # 49034)	49034-5011	1
BOLT,HEX HEAD,8X72 (Ref # 92001)	92003-107	1
"O" RING,91MM (Ref # 92055)	92055-052	1
"O" RING (Ref # 92055A)	92055-077	1
PLUG,OIL DRAIN,12X15 (Ref # 92066)	92066-1174	1
BOLT,FLANGED,6X25 (Ref # 130)	130G0625	1
"O" RING,8MM (Ref # 670)	670B1508	1
"O" RING,90MM (Ref # 671)	671B2590	1