

1981 KX250 PARTS DIAGRAM

SWING ARM (KX250-A7)

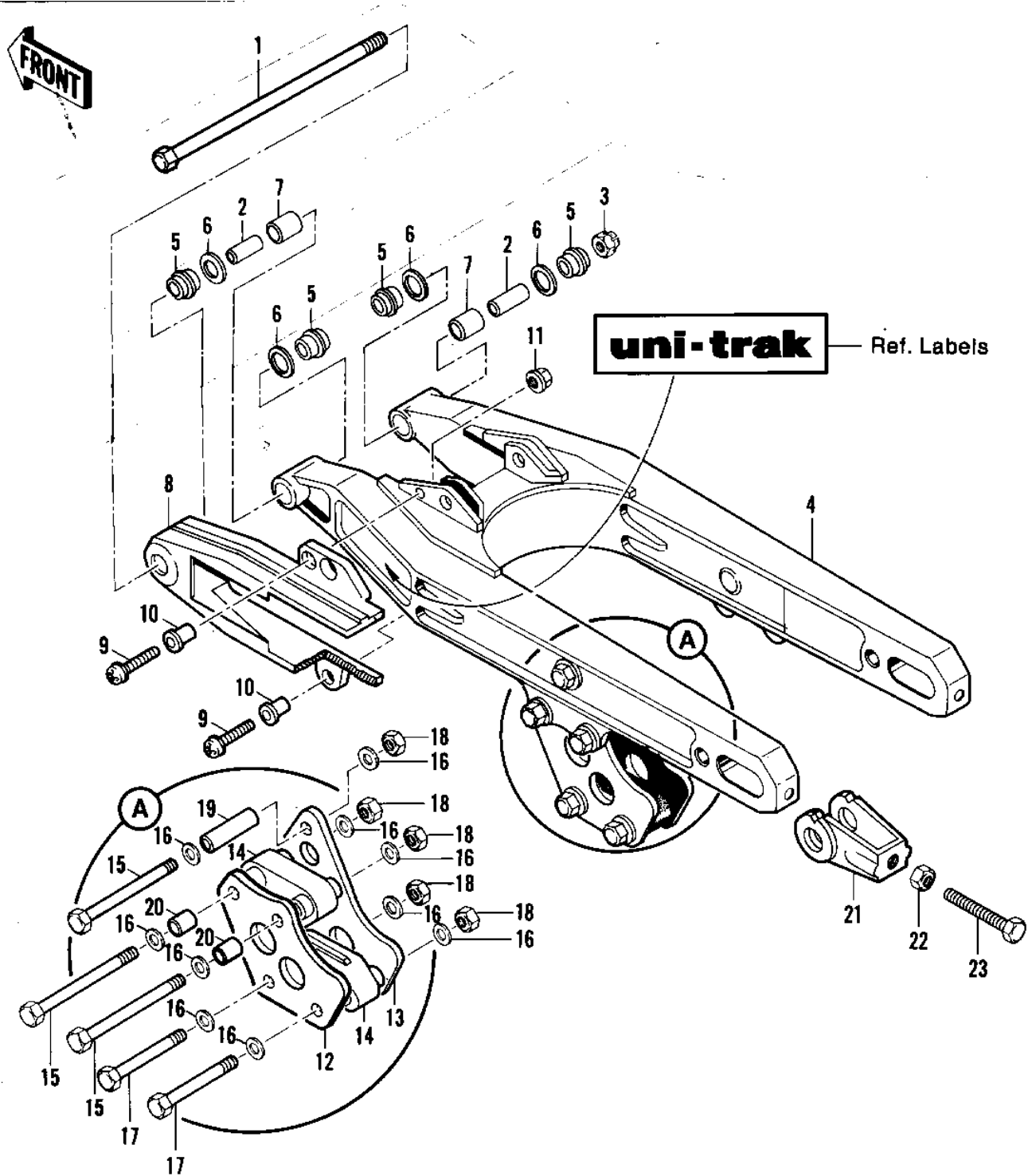

1981 KX250 PARTS LIST

SWING ARM (KX250-A7)

ITEM NAME	PART NUMBER	QUANTITY
SHAFT-SWING ARM (Ref # 1)	33032-1020	1
SLEEVE,SWING ARM (Ref # 2)	42036-1031	1
NUT-LOCK,14MM (Ref # 3)	92019-011	1
SWING ARM (Ref # 4)	33001-4003	1
CAP,SWING ARM (Ref # 5)	11012-1099	1
SHIM,SWING ARM (Ref # 6)	92025-1116	1
BUSHING (Ref # 7)	92028-1072	1
GUIDE,CHAIN (Ref # 8)	12053-4001	1
SCREW,6X20 (Ref # 9)	92009-1289	1
COLLAR (Ref # 10)	92027-1260	1
NUT-6MM (Ref # 11)	92015-1078	1
GUARD,CHAIN (Ref # 12)	55020-4009	1
GUARD,CHAIN (Ref # 13)	55020-4010	1
GUIDE,CHAIN (Ref # 14)	12053-1015	1
BOLT-UPSET (Ref # 15)	112G0660	1
WASHER PLAIN 6MM (Ref # 16)	411B0600	1
BOLT-UPSET (Ref # 17)	112G0645	1
NUT (Ref # 18)	92019-008	1
COLLAR (Ref # 19)	92027-4016	1
COLLAR (Ref # 20)	92027-4017	1
ADJUSTER,CHAIN (Ref # 21)	33040-4004	1
NUT 8MM (Ref # 22)	318G0800	1
BOLT,CHAIN ADJUSTER (Ref # 23)	92001-1027	1