

2000 Ultra 150 PARTS DIAGRAM

Cylinder Head/Cylinder

E1110

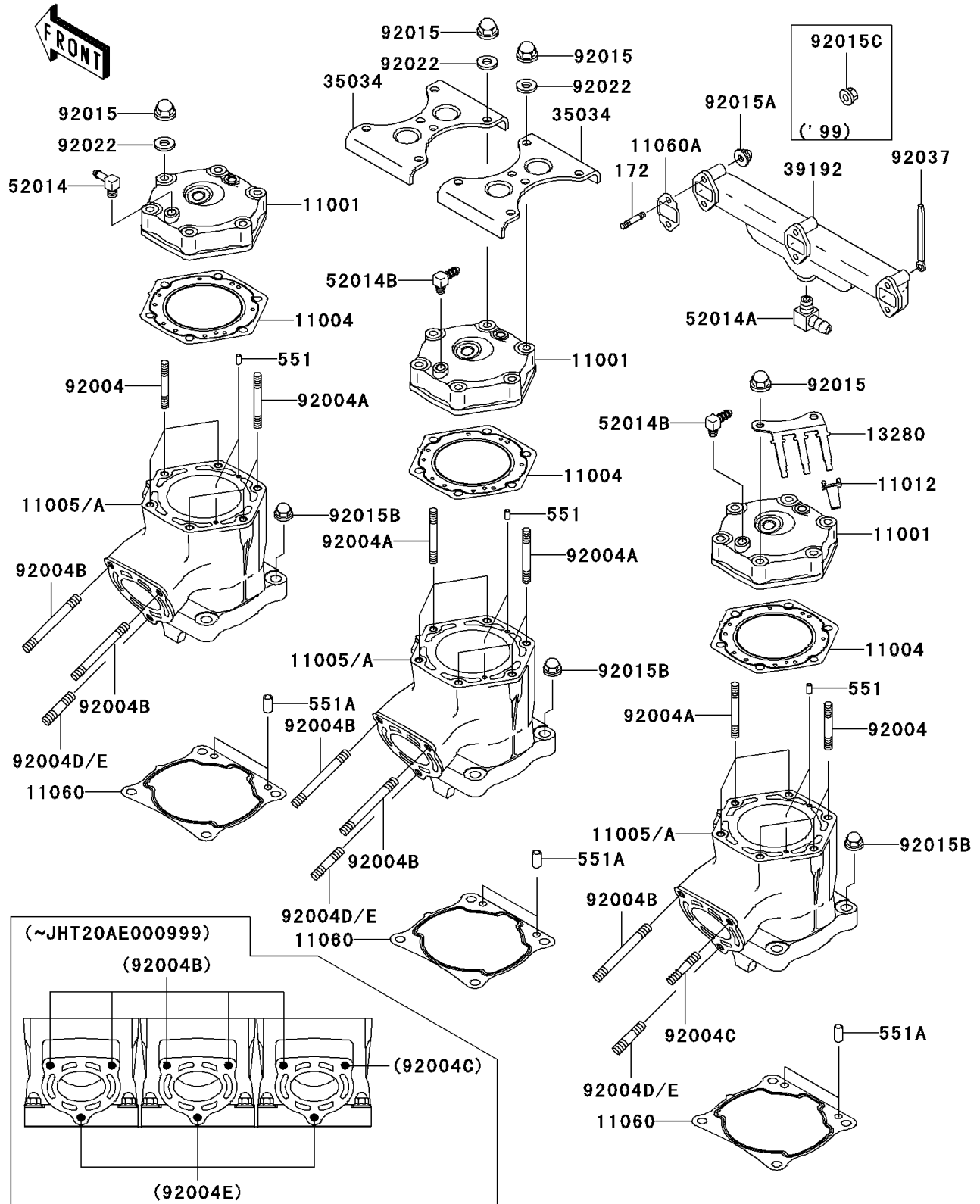

2000 Ultra 150 PARTS LIST

Cylinder Head/Cylinder

ITEM NAME	PART NUMBER	QUANTITY
BOLT-STUD,6X35 (Ref # 172)	172R0635	1
PIN-DOWEL (Ref # 551)	551R0408	1
PIN-DOWEL (Ref # 551A)	551R0812	1
HEAD-CYLINDER (Ref # 11001)	11001-3741	1
GASKET-HEAD (Ref # 11004)	11004-3717	1
CYLINDER-ENGINE (Ref # 11005)	11005-3744	1
CAP,HOLDER (Ref # 11012)	11012-3768	1
GASKET,CYLINDER BASE (Ref # 11060)	11060-3783	1
GASKET,WATER PIPE (Ref # 11060A)	11060-3784	1
HOLDER (Ref # 13280)	13280-3720	1
REINFORCE (Ref # 35034)	35034-3726	1
PIPE-WATER (Ref # 39192)	39192-3701	1
ELBOW (Ref # 52014)	52014-3709	1
ELBOW (Ref # 52014A)	52014-3711	1
ELBOW (Ref # 52014B)	52014-3713	1
STUD,8X43 (Ref # 92004)	92004-3715	1
STUD,8X53 (Ref # 92004A)	92004-3734	1
STUD,8X97 (Ref # 92004B)	92004-3735	1
STUD,8X40,L=56 (Ref # 92004C)	92004-3736	2
NUT,CAP,8MM (Ref # 92015)	92015-1371	1
NUT,CAP,6MM (Ref # 92015A)	92015-1385	1
NUT,10MM (Ref # 92015B)	92015-1649	1
WASHER,8.2X18X1.5 (Ref # 92022)	92022-1964	1
CLAMP,L=100 (Ref # 92037)	92037-3736	1