

1995 TS PARTS DIAGRAM

Drive Shaft

E3134

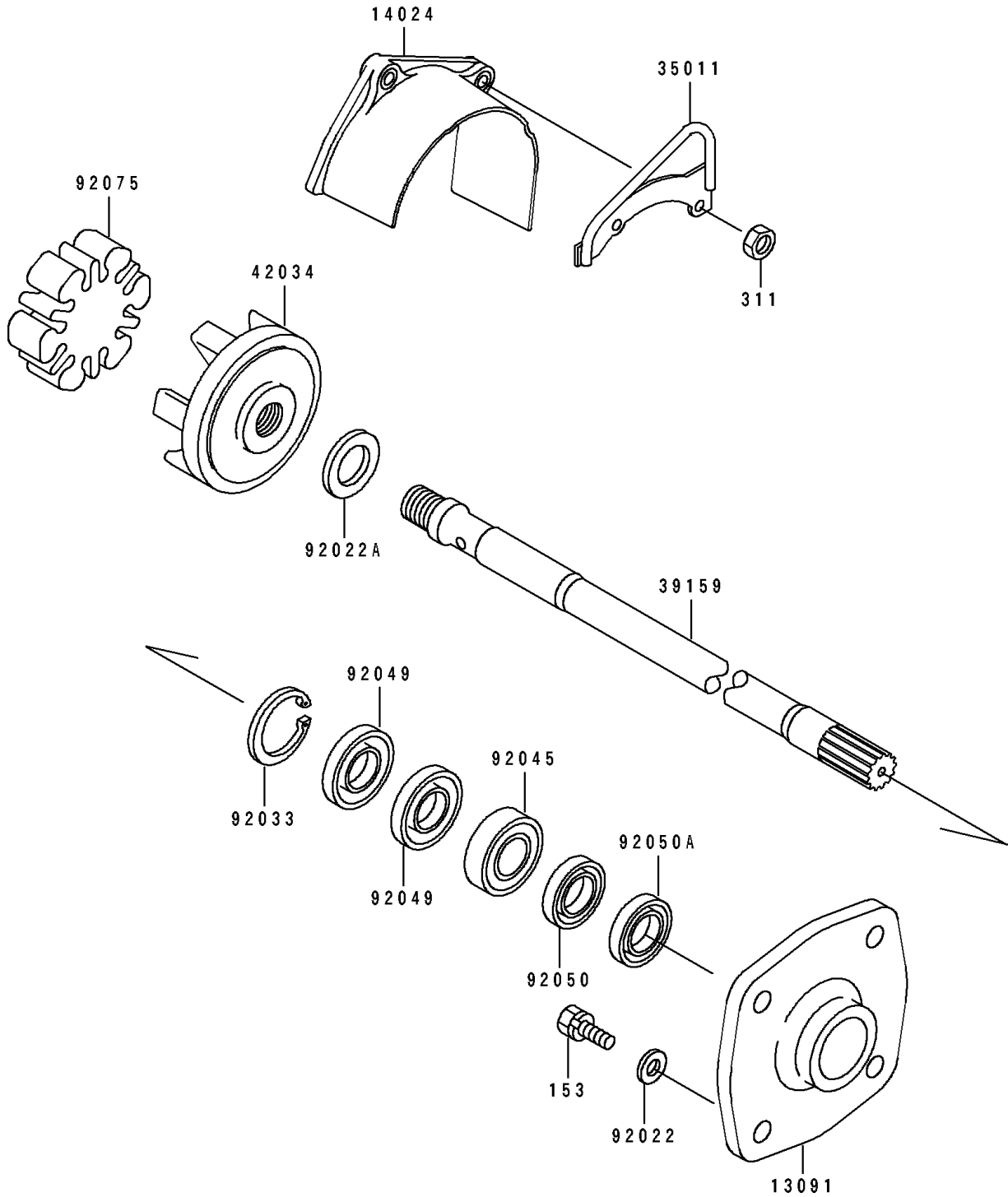

1995 TS PARTS LIST

Drive Shaft

ITEM NAME	PART NUMBER	QUANTITY
HOLDER (Ref # 13091)	13091-3730	1
COVER,COUPLING (Ref # 14024)	14024-3728	1
STAY (Ref # 35011)	35011-3704	1
SHAFT-DRIVE (Ref # 39159)	39159-3713	1
COUPLING (Ref # 42034)	42034-3705	1
WASHER,8.2X18X1.5 (Ref # 92022)	92022-1964	1
WASHER,18X26X2.0 (Ref # 92022A)	92022-3728	1
RING-SNAP,42MM (Ref # 92033)	92033-3713	1
BEARING-BALL,60042RD (Ref # 92045)	92045-3705	1
SEAL-OIL,S620426 (Ref # 92049)	92049-3707	1
SEAL-OIL,SCY20368 (Ref # 92050)	92050-502	1
SEAL-OIL,SC20367 (Ref # 92050A)	92050-503	1
DAMPER,COUPLING (Ref # 92075)	92075-520	1
BOLT-WS-SMALL (Ref # 153)	153R0825	1
NUT-HEX,6MM (Ref # 311)	311R0600	1