

# 1991 X2 PARTS DIAGRAM

Hull

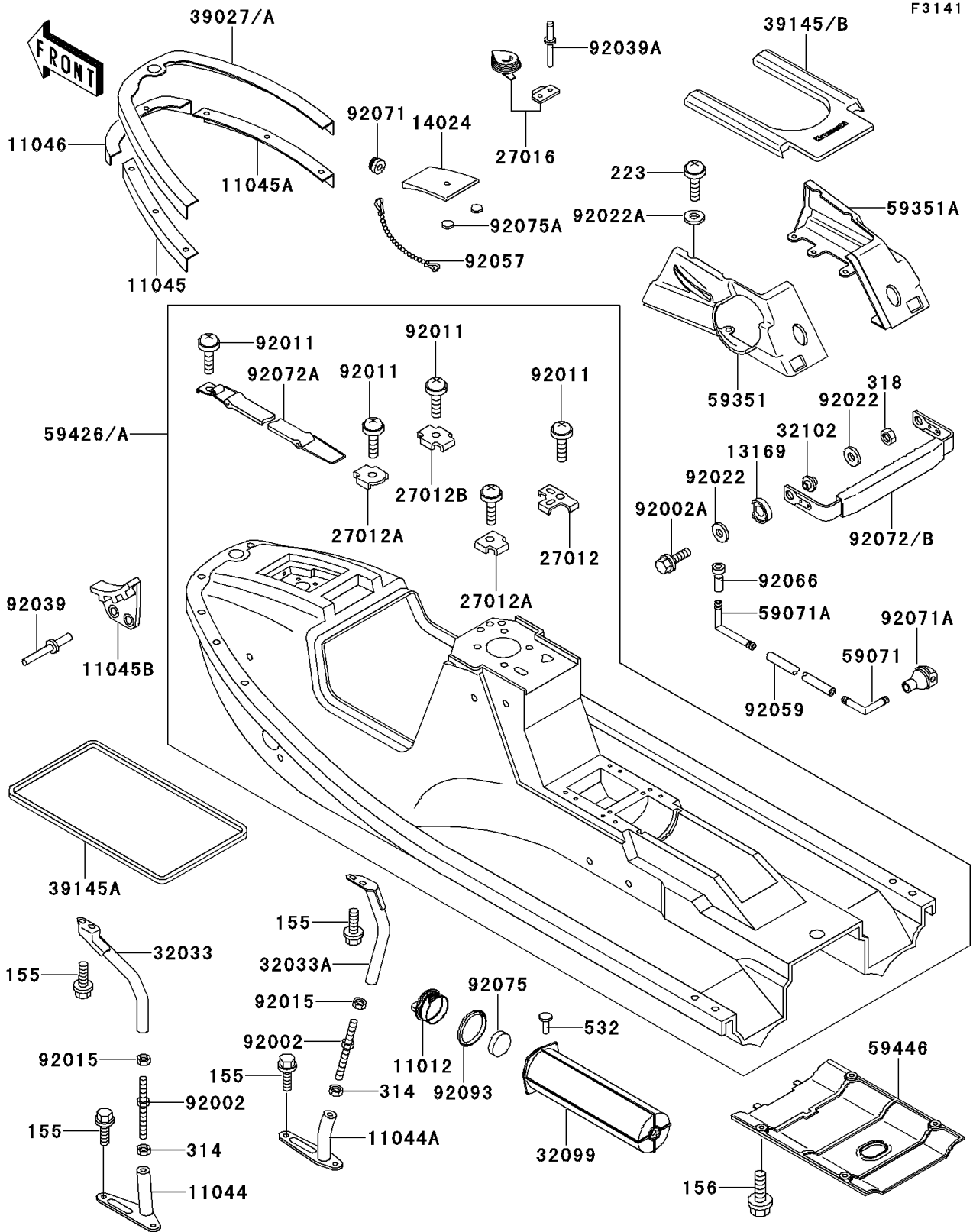

# 1991 X2 PARTS LIST

## Hull

ITEM NAME	PART NUMBER	QUANTITY
CAP (Ref # 11012)	11012-3708	1
BRACKET,DECK,LH (Ref # 11044)	11044-3710	1
BRACKET,DECK,RH (Ref # 11044A)	11044-3711	1
BRACKET,BUMPER,LH (Ref # 11045)	11045-3711	1
BRACKET,BUMPER,RH (Ref # 11045A)	11045-3712	1
BRACKET (Ref # 11045B)	11045-3755	1
BRACKET,BUMPER,CNT (Ref # 11046)	11046-3818	1
PLATE (Ref # 13169)	13169-3714	2
COVER,TANK CAP,JET WHITE (Ref # 14024)	14024-3731-8C	1
HOOK (Ref # 27012)	27012-3705	1
HOOK (Ref # 27012A)	27012-501	2
HOOK (Ref # 27012B)	27012-502	1
LOCK-ASSY,TANK CAP COVER (Ref # 27016)	27016-3705	1
PIPE,DECK,LH (Ref # 32033)	32033-3718	1
PIPE,DECK,RH (Ref # 32033A)	32033-3719	1
CASE,FIRE EXT. (Ref # 32099)	32099-3705	1
PIPE (Ref # 32102)	32102-3704	2
BUMPER-FRONT (Ref # 39027)	39027-3710	1
TRIM-SEAL,DECK (Ref # 39145)	39145-3702	1
TRIM-SEAL (Ref # 39145A)	39145-3726	1
JOINT (Ref # 59071)	59071-3706	1
JOINT (Ref # 59071A)	59071-3733	1
DECK,LH,JET WHITE (Ref # 59351)	59351-3708-8C	1
DECK,RH,JET WHITE (Ref # 59351A)	59351-3709-8C	1
HULL-COMP,JET WHITE (Ref # 59426)	59426-3781-8C	1
COVER-JET PUMP (Ref # 59446)	59446-3703	1
BOLT,10MM (Ref # 92002)	92002-3731	2
BOLT,8X30 (Ref # 92002A)	92002-3742	2
SCREW,TAPPING (Ref # 92011)	92011-561	6

# 1991 X2 PARTS LIST

## Hull

ITEM NAME	PART NUMBER	QUANTITY
NUT,10MM (Ref # 92015)	92015-3737	2
WASHER,8.5X19X1.2 (Ref # 92022)	92022-3730	4
WASHER (Ref # 92022A)	92022-567	8
RIVET (Ref # 92039)	92039-3002	2
RIVET (Ref # 92039A)	92039-3714	2
CHAIN,COVER,L=250 (Ref # 92057)	92057-3701	1
TUBE,5.8X10.8X220 (Ref # 92059)	92059-3765	1
BOLT-WSP-SMALL,8X16 (Ref # 155)	155R0816	8
BOLT-WP,6X22 (Ref # 156)	156R0622	4
SCREW-PAN-WS-CROS,6X20 (Ref # 223)	223R0620	8
NUT-HEX-FINE,10MM (Ref # 314)	314R1000	2
NUT-HEX-SMALL (Ref # 318)	318R0800	2
RIVET-FLAT (Ref # 532)	532R0508	2
PLUG (Ref # 92066)	92066-3706	1
GROMMET (Ref # 92071)	92071-3733	1
GROMMET (Ref # 92071A)	92071-3736	1
BAND,TANDEM (Ref # 92072)	92072-3711	1
BAND,L=318 (Ref # 92072A)	92072-3723	2
DAMPER (Ref # 92075)	92075-3719	1
DAMPER (Ref # 92075A)	92075-3760	2
SEAL,OSR70X82X7.5 (Ref # 92093)	92093-3704	1