

1989 Jet Mate PARTS DIAGRAM

Engine Hood

(F3142)

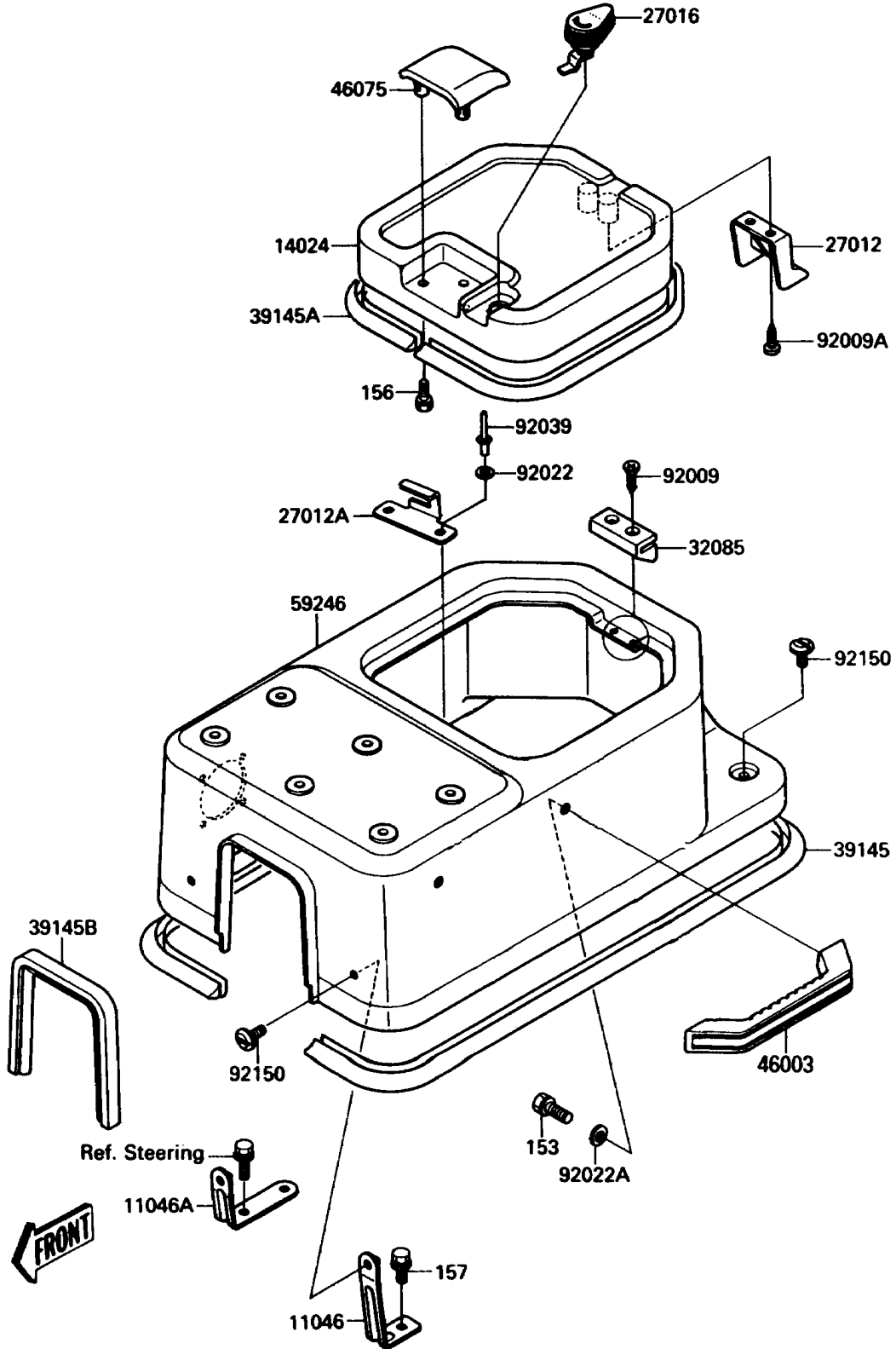

1989 Jet Mate PARTS LIST

Engine Hood

ITEM NAME	PART NUMBER	QUANTITY
BRACKET,ENGINE HOOD,LH (Ref # 11046)	11046-3766	1
BRACKET,ENGINE HOOD,RH (Ref # 11046A)	11046-3767	1
COVER,ENGINE HOOD,P.WHITE (Ref # 14024)	14024-3766-F1	1
HOOK,ENGINE HOOD COVER (Ref # 27012)	27012-3745	1
HOOK,LOCK (Ref # 27012A)	27012-3748	1
LOCK-ASSY (Ref # 27016)	27016-3712	1
STOPPER,ENGINE HOOD (Ref # 32085)	32085-3715	1
TRIM-SEAL (Ref # 39145)	39145-3711	1
TRIM-SEAL (Ref # 39145A)	39145-3712	1
TRIM-SEAL (Ref # 39145B)	39145-3717	1
GRIP (Ref # 46003)	46003-2054	1
GRIP,ENGINE HOOD COVER,P.WHITE (Ref # 46075)	46075-3718-F1	1
HOOD-ENGINE,P.WHITE (Ref # 59246)	59246-3715-BP	1
SCREW,TAPPING,4X14 (Ref # 92009)	92009-3755	2
SCREW,TAPPING,5X20 (Ref # 92009A)	92009-3756	2
WASHER,5X16X1.5 (Ref # 92022)	92022-3041	2
WASHER,8.5X19X1.2 (Ref # 92022A)	92022-3730	2
RIVET,4.8MM (Ref # 92039)	92039-3719	2
BOLT,6X14 (Ref # 92150)	92150-3732	4
BOLT-WS-SMALL,8X18 (Ref # 153)	153R0818	2
BOLT-WP,5X16 (Ref # 156)	156R0516	3
BOLT-WSP,6X16 (Ref # 157)	157R0616	1