

# 2003 Ninja® 500R PARTS DIAGRAM

Meter(s)

F2530

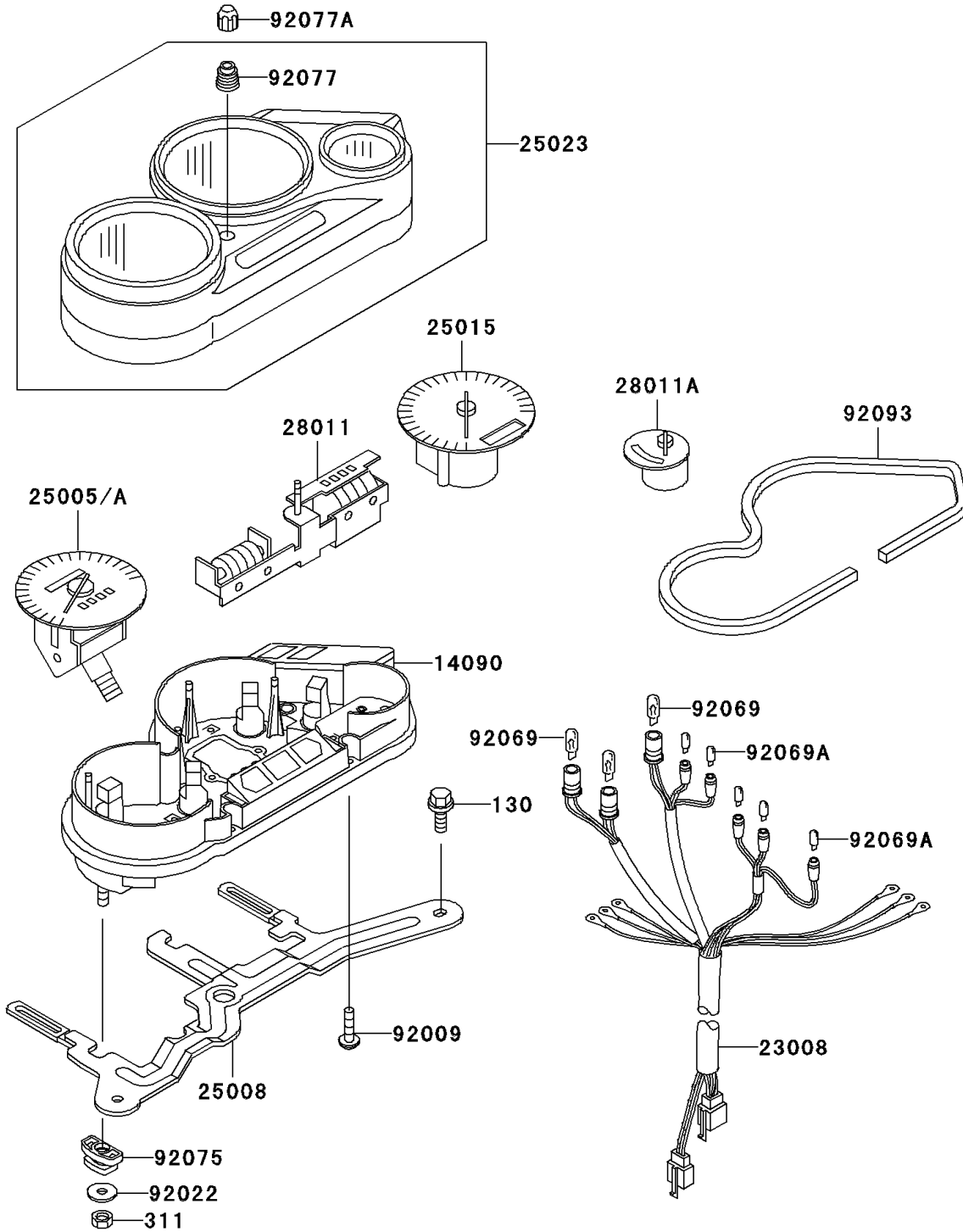

## 2003 Ninja® 500R PARTS LIST

Meter(s)

ITEM NAME	PART NUMBER	QUANTITY
BOLT-FLANGED,6X12 (Ref # 130)	130C0612	2
NUT-HEX (Ref # 311)	311B0500	3
COVER,METER HOUSING (Ref # 14090)	14090-1869	1
SOCKET-ASSY,METER (Ref # 23008)	23008-1431	1
BRACKET-METER (Ref # 25008)	25008-1160	1
TACHOMETER,X1000R/MIN (Ref # 25015)	25015-1327	1
COVER-METER CASE,UPP (Ref # 25023)	25023-1167	1
METER,TRIP (Ref # 28011)	28011-1118	1
METER,TEMP (Ref # 28011A)	28011-1144	1
SCREW,TAPPING,4X16 (Ref # 92009)	92009-1163	5
WASHER,5.2X16X1.2 (Ref # 92022)	92022-263	3
BULB,12V 1.7W,T10 (Ref # 92069)	92069-1059	3
BULB,12V 3W,T6.5 (Ref # 92069A)	92069-1068	5
DAMPER,METER BRACKET (Ref # 92075)	92075-1495	3
KNOB,TRIP RESET (Ref # 92077)	92077-1087	1
KNOB,TRIP RESET (Ref # 92077A)	92077-1094	1
SEAL (Ref # 92093)	92093-1373	1
SPEEDOMETER,KPH (Ref # 25005)	25005-1706	1
SPEEDOMETER,MPH (Ref # 25005A)	25005-1729	1