

2003 Ninja® 500R PARTS DIAGRAM

Front Master Cylinder

F2291

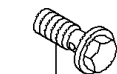
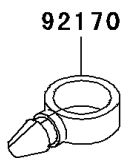
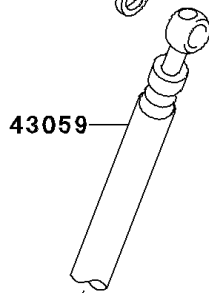
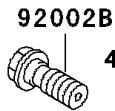
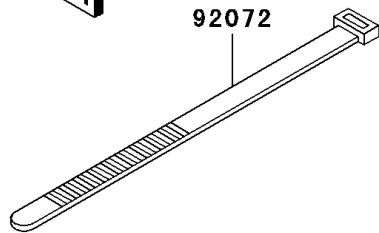

92002B

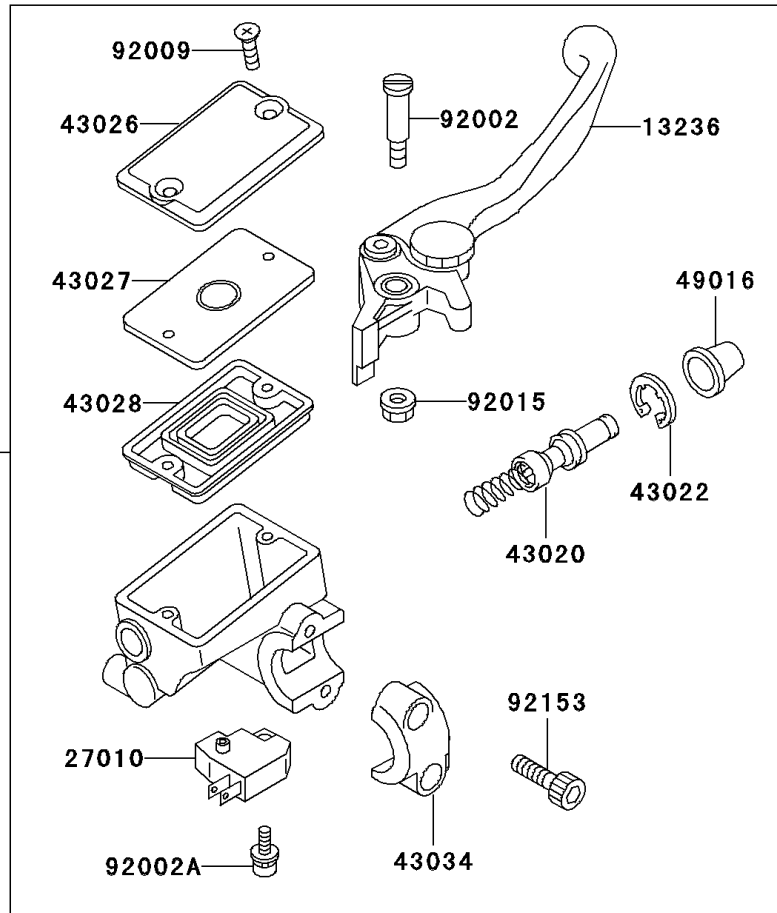

Ref. Chassis Electrical Equipment

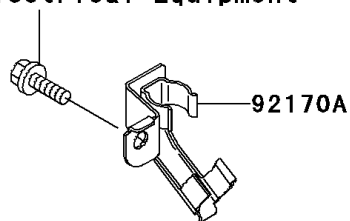

2003 Ninja® 500R PARTS LIST

Front Master Cylinder

ITEM NAME	PART NUMBER	QUANTITY
LEVER-COMP,FRONT BRAKE (Ref # 13236)	13236-1185	1
SWITCH,BRAKE (Ref # 27010)	27010-1170	1
CYLINDER-ASSY-MASTER,FR (Ref # 43015)	43015-1479	1
PISTON-COMP-BRAKE,FR (Ref # 43020)	43020-1056	1
STOPPER-BRAKE,PISTON (Ref # 43022)	43022-1010	1
CAP-BRAKE (Ref # 43026)	43026-1076	1
PLATE-DIAPHRAGM (Ref # 43027)	43027-1055	1
DIAPHRAGM,MASTER CYLINDER (Ref # 43028)	43028-1058	1
HOLDER-BRAKE,MASTER CYLINDER (Ref # 43034)	43034-1053	1
HOSE-BRAKE,FR (Ref # 43059)	43059-1860	1
WASHER,10.5X15X1.5 (Ref # 43067)	43067-001	4
COVER-SEAL,MASTER CYLINDER (Ref # 49016)	49016-1044	1
BOLT,LEVER SET,BLACK (Ref # 92002)	92002-1322	1
BOLT,SCREW,4X12 (Ref # 92002A)	92002-1323	1
BOLT,OIL,L=23 (Ref # 92002B)	92002-1907	2
SCREW,4MM (Ref # 92009)	92009-1458	2
NUT,FLANGED,6MM,BLACK (Ref # 92015)	92015-1233	1
BAND,L=202 (Ref # 92072)	92072-1195	1
BOLT,SOCKET,6X20 (Ref # 92153)	92153-0417	2
CLAMP (Ref # 92170)	92170-1067	1
CLAMP,HOSE (Ref # 92170A)	92170-1499	1