

# 1995 Ninja® 500 PARTS DIAGRAM

Rear Suspension

F2150

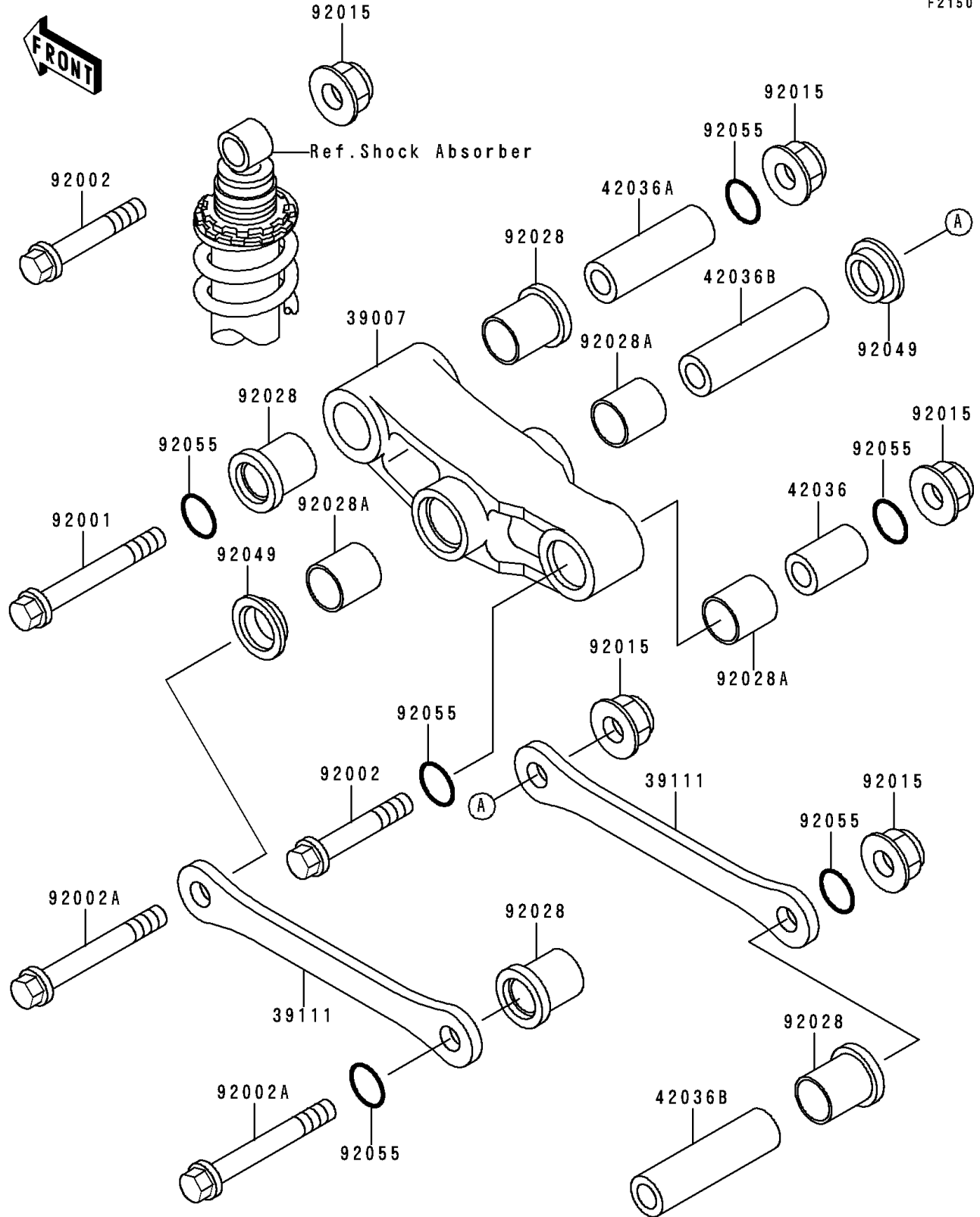

# 1995 Ninja® 500 PARTS LIST

## Rear Suspension

ITEM NAME	PART NUMBER	QUANTITY
ARM-SUSP,UNI TRAK (Ref # 39007)	39007-1120	1
ROD-TIE,SUSPENSION (Ref # 39111)	39111-1133	2
SLEEVE,ARM,RR (Ref # 42036)	42036-1077	1
SLEEVE,ARM,FR (Ref # 42036A)	42036-1078	1
SLEEVE,12.1X20X74 (Ref # 42036B)	42036-1102	2
BOLT,12X90 (Ref # 92001)	92001-1937	1
BOLT,12X55 (Ref # 92002)	92002-1130	2
BOLT,FLANGED,12X100 (Ref # 92002A)	92002-1886	2
NUT,FLANGED,12MM (Ref # 92015)	92015-1433	5
BUSHING (Ref # 92028)	92028-1597	4
BUSHING (Ref # 92028A)	92028-1598	3
SEAL-OIL,ARM,CNT (Ref # 92049)	92049-1109	2
RING-O,19.8X2.2 (Ref # 92055)	92055-1215	6