

1988 EX500 PARTS DIAGRAM

Chassis Electrical Equipment

F2760-0387

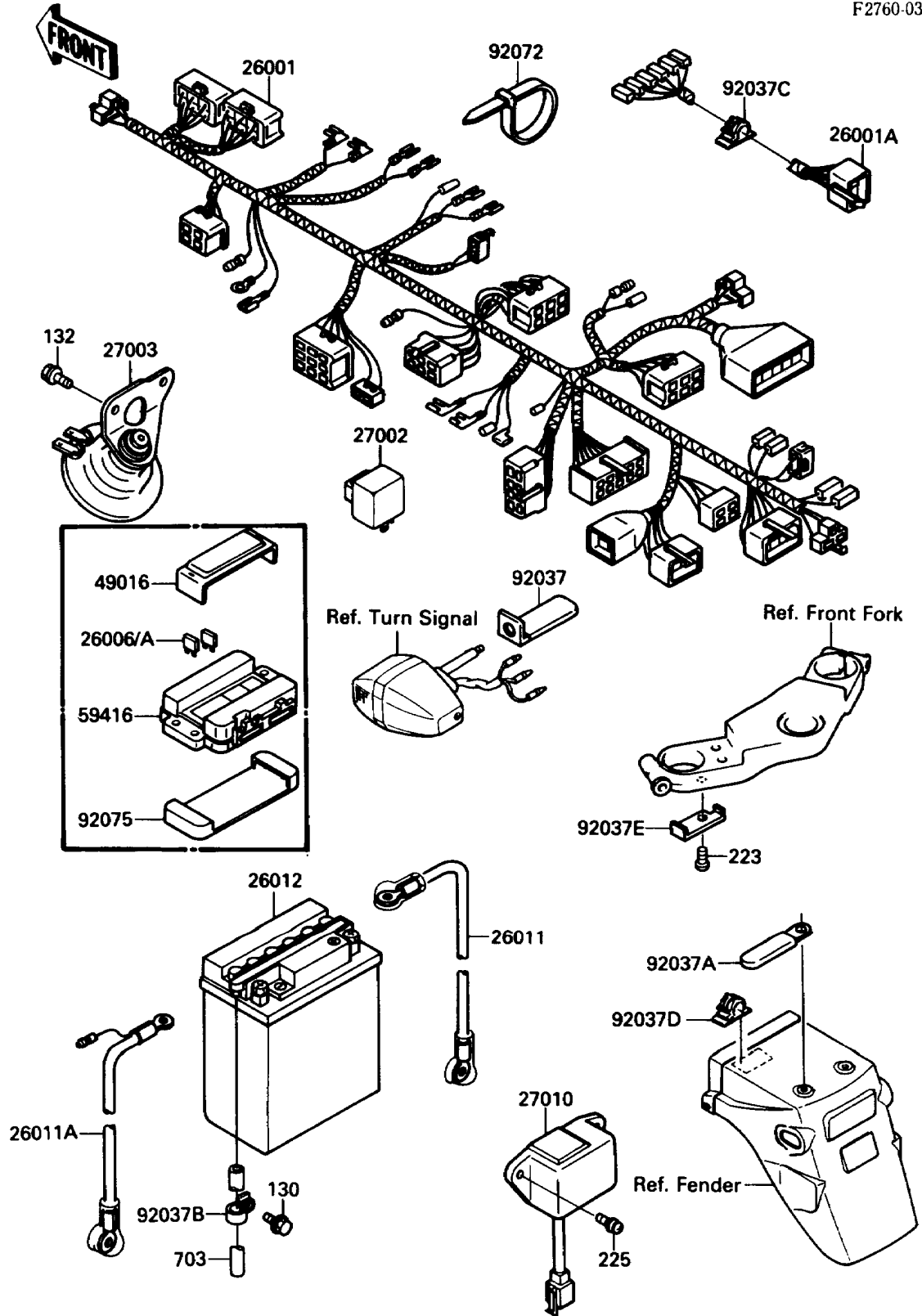

1988 EX500 PARTS LIST

Chassis Electrical Equipment

ITEM NAME	PART NUMBER	QUANTITY
HARNESS,MAIN (Ref # 26001)	26001-1829	1
HARNESS,FRONT SIGNAL LAMP (Ref # 26001A)	26001-1859	1
FUSE,30A-G (Ref # 26006)	26006-1006	1
FUSE,10A-R (Ref # 26006A)	26006-1007	5
WIRE-LEAD,BATTERY(+) (Ref # 26011)	26011-1388	1
WIRE-LEAD,BATTERY(-) (Ref # 26011A)	26011-1389	1
BATTERY,12V 14AH,FB14L-A2 (Ref # 26012)	26012-1219	1
RELAY-ASSY,TURN SIGNAL (Ref # 27002)	27002-1060	1
HORN (Ref # 27003)	27003-1274	1
SWITCH,RESERV LIGHTING (Ref # 27010)	27010-1066	1
COVER-SEAL,FUSE (Ref # 49016)	49016-1125	1
CASE-ELECTRIC,JUNCTION BOX (Ref # 59416)	59416-1059	1
CLAMP,HARNESS (Ref # 92037)	92037-1316	2
CLAMP,WIRING HARNESS (Ref # 92037A)	92037-1539	1
CLAMP,HOSE (Ref # 92037B)	92037-1727	1
CLAMP,TUBE (Ref # 92037C)	92037-1794	2
CLAMP,HARNESS (Ref # 92037D)	92037-1816	1
CLAMP,HARNESS (Ref # 92037E)	92037-1916	1
BAND,L=185 (Ref # 92072)	92072-1195	9
DAMPER,JUNCTION BOX (Ref # 92075)	92075-1688	1
BOLT-FLANGED,6X10 (Ref # 130)	130B0610	2
BOLT-FLANGED-SMALL,6X10 (Ref # 132)	132J0610	2
SCREW-PAN-WS-CROS (Ref # 223)	223B0610	1
SCREW-PAN-WSP-CROS (Ref # 225)	225B0620	2
TUBE-RUBBER,8X12X530 (Ref # 703)	703A08530	1