

1987 EX500 PARTS DIAGRAM

Brake Pedal/Torque Link

F2260-0184

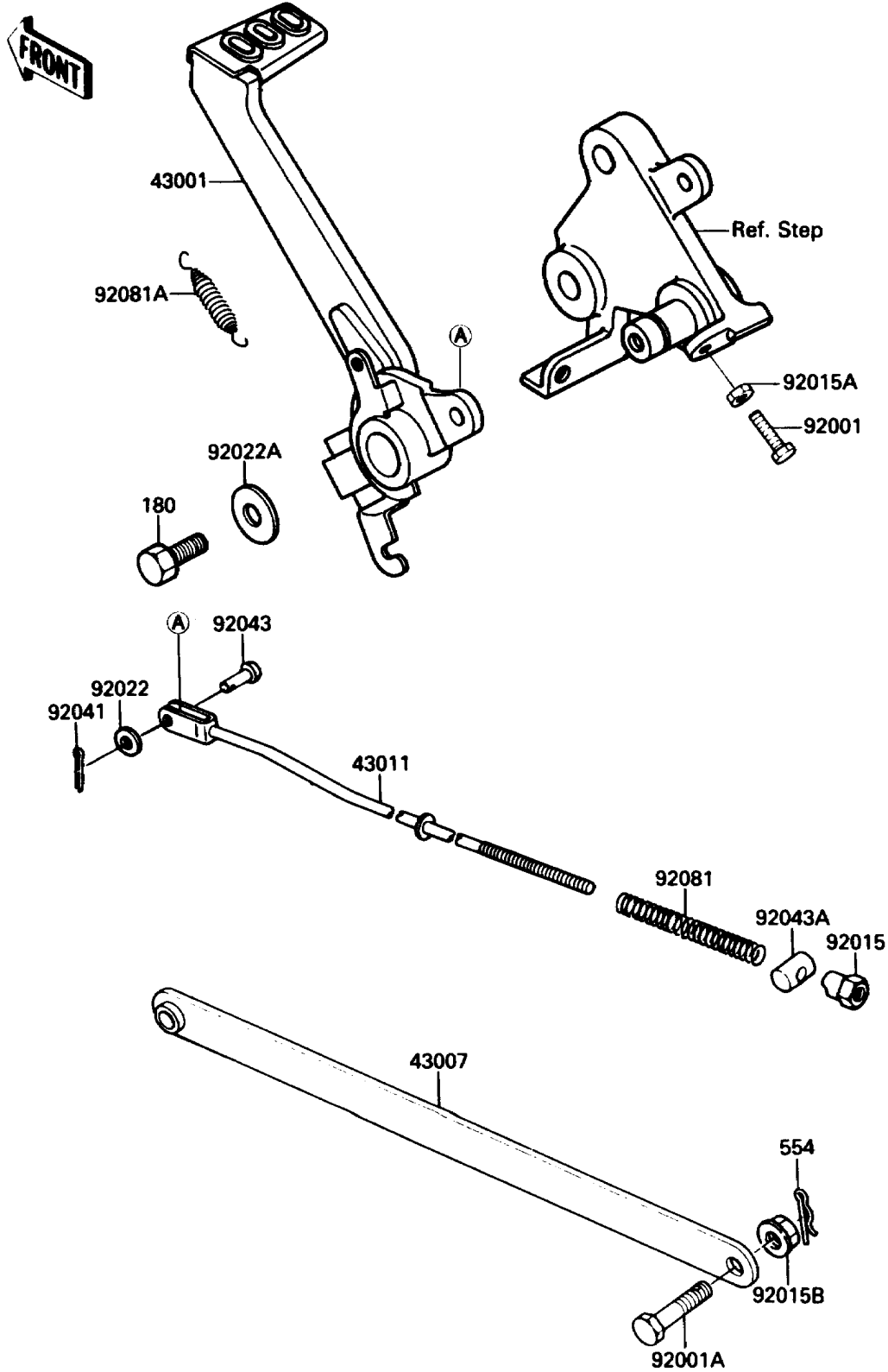

1987 EX500 PARTS LIST

Brake Pedal/Torque Link

ITEM NAME	PART NUMBER	QUANTITY
LEVER-BRAKE,PEDAL (Ref # 43001)	43001-1219	1
ROD-TORQUE (Ref # 43007)	43007-1131	1
ROD-BRAKE (Ref # 43011)	43011-1136	1
BOLT,6X25 (Ref # 92001)	92001-1090	1
BOLT,10X35 (Ref # 92001A)	92003-034	1
NUT,BRAKE ROD (Ref # 92015)	92015-042	1
NUT,6MM (Ref # 92015A)	92015-1391	1
NUT,FLANGED,10MM (Ref # 92015B)	92015-1428	1
WASHER,6.5X11.5X0.8 (Ref # 92022)	92022-1556	1
WASHER,6.5X20X1.6 (Ref # 92022A)	92022-1557	1
COTER,2.0X15 (Ref # 92041)	92041-1052	1
PIN,6X17 (Ref # 92043)	92043-064	1
PIN,BRAKE ROD (Ref # 92043A)	92043-065	1
SPRING,BRAKE ROD (Ref # 92081)	43012-001	1
SPRING,BRAKE PEDAL (Ref # 92081A)	92081-1147	1
BOLT-UPSET-WS (Ref # 180)	180D0616	1
PIN-SNAP,8MM (Ref # 554)	554A0800	1