

1988 EX500 PARTS DIAGRAM

Transmission

E1361-0186

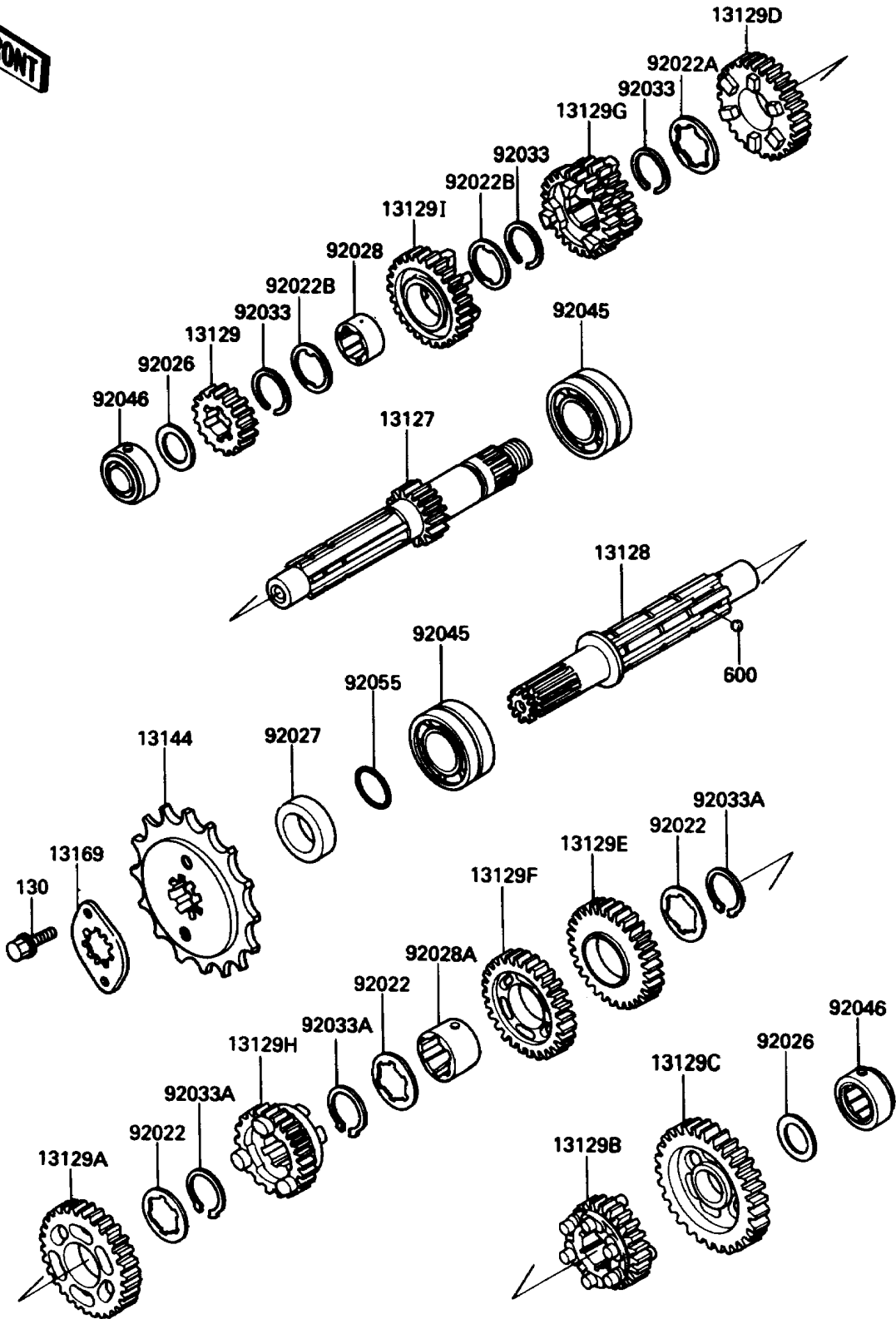

1988 EX500 PARTS LIST

Transmission

ITEM NAME	PART NUMBER	QUANTITY
SHAFT-TRANSMISSION INPUT,14T (Ref # 13127)	13127-1148	1
SHAFT-TRANSMISSION OUTPUT (Ref # 13128)	13128-1143	1
GEAR,INPUT 2ND,18T (Ref # 13129)	13129-1077	1
GEAR,OUTPUT 2ND,32T (Ref # 13129A)	13129-1078	1
GEAR,OUTPUT 5TH,25T (Ref # 13129B)	13129-1083	1
GEAR,OUTPUT LOW,36T (Ref # 13129C)	13129-1564	1
GEAR,INPUT 5TH,26T (Ref # 13129D)	13129-1657	1
GEAR,OUTPUT 3RD,29T (Ref # 13129E)	13129-1659	1
GEAR,OUTPUT 4TH,27T (Ref # 13129F)	13129-1660	1
GEAR,INPUT 3RD&4TH,21T&24T (Ref # 13129G)	13129-1846	1
GEAR,OUTPUT TOP,23T (Ref # 13129H)	13129-1858	1
GEAR,INPUT TOP,27T (Ref # 13129I)	13129-1859	1
SPROCKET-OUTPUT,16T (Ref # 13144)	13144-1085	1
PLATE,SPROCKET (Ref # 13169)	13169-1109	1
WASHER,TOOTHED,28.3X33.5X1 (Ref # 92022)	92022-1139	3
WASHER,TOOTHED,25.3X31.8X1.6 (Ref # 92022A)	92022-1861	1
WASHER,TOOTHED,25.5X32X1 (Ref # 92022B)	92024-033	2
SPACER,20.3X30X2.0 (Ref # 92026)	92026-1022	2
COLLAR,25X40X12 (Ref # 92027)	92027-1857	1
BUSHING,INPUT TOP GEAR (Ref # 92028)	92028-1003	1
BUSHING,OUTPUT 3RD&4TH GEAR (Ref # 92028A)	92028-1364	1
RING-SNAP,24MM (Ref # 92033)	92033-026	3
RING-SNAP,25.9MM (Ref # 92033A)	92033-1037	3
BEARING-BALL,83993SH2-CS (Ref # 92045)	92045-035	2
BEARING-NEEDLE,NKZ20X34X17 (Ref # 92046)	92046-1161	2
RING-O (Ref # 92055)	92055-035	1
BOLT-FLANGED-SMALL (Ref # 130)	130G0610	2
BALL-STEEL,5/32" (Ref # 600)	600A0500	3